

CENÍK 2010

MANDÍK®

Obsah

PKTM 90 (120) (TPM 018/01), PKTM III (TPM 075/09) Požární klapky		8
KOKTM (TPM 067/07) Klapka odvodu kouře a tepla		35
PSUM 90 (TPM 006/99) Požární stěnový uzávěr		44
PVM E90 (TPM 052/05) Požární ventil		45
VVM (TPM 001/96) Vyústě s vířivým výtokem vzduchu		46
VVPM (TPM 007/99) Vyústě vířivá s pevnými lamelami		48
ALCM (TPM 003/97) Anemostat lamelový čtvercový		49
ALKM (TPM 005/99) Anemostat lamelový kruhový		50
CHICAGO (TPM 036/05) Pohledový anemostat		51

VASM (TPM 017/01)

Vířivý anemostat se stavitelnými lamelami



52

VAPM (TPM 010/00)

Vířivý anemostat s pevnými lamelami



53

RKM (TPM 009/00)

Regulační klapka



54

RKTM (TPM 012/00)

Regulační klapka těsná



57

RKKM (TPM 030/03)

Regulační klapka kruhová



60

RKKTM (TPM 031/03)

Regulační klapka kruhová těsná



62

RPM (TPM 027/03)

Regulátor průtoku vzduchu



64

DPM (TPM 002/97)

Děrovaný panel



65

TVPM (TPM 028/03)

Talířový ventil



65

TVOM (TPM 028/03)

Talířový ventil



65

VSV (TPM 001/95)

Vyúst se štěrbinovým výtokem vzduchu



66

VPVM (TPM 013/01)

Velkoplošná vyúst



67

TVM (TPM 003/96)

Tlumící vložka čtyřhranná a kruhová



68

KMM (TPM 002/96)

Krycí mřížka čtyřhranná a kruhová



69

SMM (TPM 014/01)

Stěnová mřížka



71

VNM (TPM 015/01)

Vyústka nastavitelná



74

SVM (TPM 016/01)

Stěnová vyústka (PV)



82

SVM (TPM 016/01)

Stěnová vyústka (NV)



91

SVM (TPM 016/01) Stěnová vyústka (PS)		100
SVM (TPM 016/01) Stěnová vyústka (NS)		103
VNKM (TPM 034/04) Vyústka nastavitelná pro kruhové potrubí		112
EKOBOX (TPM 037/04)		114
DDM II (TPM 072/08) Dýza s dalekým dosahem		115
HELIOS (TPM 049/05) Infrazářič – plynový		116
HELIOS (TPM 049/05) Příslušenství k infrazářičům		118
MONZUN TEPLOVODNÍ (TPM 063/07) Teplovzdušné jednotky – teplovodní		119
MONZUN TEPLOVODNÍ (TPM 063/07) Příslušenství		120

MONZUN – VH (TPM 040/05)

Teplovzdušné jednotky plynové



121

MONZUN – CV (TPM 040/05)

Teplovzdušné jednotky plynové



122

MONZUN – VH RTI (TPM 046/05)

Teplovzdušné jednotky plynové, se směšovací komorou



123

MONZUN – CV RTI (TPM 046/05)

Teplovzdušné jednotky plynové, se směšovací komorou



124

MONZUN – CV EUROKLIM (TPM 043/05)

Teplovzdušné jednotky – plynové



125

PŘÍSLUŠENSTVÍ MONZUN

Plynové jednotky

126

MONZUN – Premix (TPM 068/08)

Teplovzdušné kondenzační jednotky – plynové



127

MONZUN – Premix (TPM 068/08)

Příslušenství

128

ROZVRSTVOVAČ – DESTRAFIFIKÁTOR (TPM 048/05)

Podstropní ventilátor

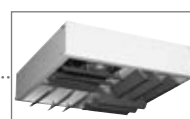

130

PKTM 90 (120) (TPM 018/01)**PKTM III** (TPM 075/09)

Požární klapky



Požární klapky									
Klapka	Rozměr (mm)	Provedení a cena v Kč							
		.01	.11	.20	.21/.22	.23	.24/.25	.40	
PKTM III	160×160	1 957	2 227	3 287	4 557	3 517	4 777	6 189	
PKTM III	160×180	2 424	2 694	3 754	5 024	3 984	5 244	6 657	
PKTM III	160×200	2 004	2 274	3 334	4 604	3 564	4 824	6 237	
PKTM III	160×250	2 101	2 371	3 431	4 701	3 661	4 921	6 333	
PKTM III	160×280	2 136	2 406	3 466	4 736	3 696	4 956	6 368	
PKTM III	160×300	2 163	2 433	3 493	4 763	3 723	4 983	6 395	
PKTM III	160×315	2 181	2 451	3 511	4 781	3 741	5 001	6 413	
PKTM III	160×355	2 310	2 580	3 640	4 910	3 870	5 130	6 542	
PKTM III	160×400	2 367	2 637	3 697	4 967	3 927	5 187	6 599	
PKTM III	160×450	2 426	2 696	3 756	5 026	3 986	5 246	7 967	
PKTM III	160×500	2 488	2 758	3 818	5 088	4 048	5 308	8 029	
PKTM III	160×550	2 546	2 816	3 876	5 146	4 106	5 366	8 087	
PKTM III	160×560	2 558	2 828	3 888	5 158	4 118	5 378	8 099	
PKTM III	160×600	2 634	2 904	3 964	5 234	4 194	5 454	8 175	
PKTM III	160×630	2 669	2 939	3 999	5 269	4 229	5 489	8 210	
PKTM III	160×650	2 696	2 966	4 026	5 296	4 256	5 516	8 237	
PKTM III	160×710	2 769	3 039	4 099	5 369	4 329	5 589	8 310	
PKTM III	160×750	2 818	3 088	4 148	5 418	4 378	5 638	8 359	
PKTM III	160×800	2 878	3 148	4 208	5 478	4 438	5 698	8 419	
PKTM III	160×900	3 132	3 402	4 462	5 732	4 692	5 952	8 673	
PKTM III	160×1 000	3 277	3 547	4 607	5 877	4 837	6 097	8 818	
PKTM III	180×160	1 980	2 250	3 310	4 580	3 540	4 800	6 212	
PKTM III	180×180	2 005	2 275	3 335	4 605	3 565	4 825	6 237	
PKTM III	180×200	2 030	2 300	3 360	4 630	3 590	4 850	6 263	
PKTM III	180×250	2 127	2 397	3 457	4 727	3 687	4 947	6 359	
PKTM III	180×280	2 167	2 437	3 497	4 767	3 727	4 987	6 399	
PKTM III	180×300	2 195	2 465	3 525	4 795	3 755	5 015	6 427	
PKTM III	180×315	2 212	2 482	3 542	4 812	3 772	5 032	6 444	
PKTM III	180×355	2 344	2 614	3 674	4 944	3 904	5 164	6 577	
PKTM III	180×400	2 404	2 674	3 734	5 004	3 964	5 224	6 636	
PKTM III	180×450	2 469	2 739	3 799	5 069	4 029	5 289	8 010	
PKTM III	180×500	2 531	2 801	3 861	5 131	4 091	5 351	8 072	
PKTM III	180×550	2 594	2 864	3 924	5 194	4 154	5 414	8 135	
PKTM III	180×560	2 607	2 877	3 937	5 207	4 167	5 427	8 148	
PKTM III	180×600	2 683	2 953	4 013	5 283	4 243	5 503	8 224	
PKTM III	180×630	2 723	2 993	4 053	5 323	4 283	5 543	8 264	
PKTM III	180×650	2 750	3 020	4 080	5 350	4 310	5 570	8 291	
PKTM III	180×710	2 826	3 096	4 156	5 426	4 386	5 646	8 367	
PKTM III	180×750	2 878	3 148	4 208	5 478	4 438	5 698	8 419	
PKTM III	180×800	2 943	3 213	4 273	5 543	4 503	5 763	8 484	
PKTM III	180×900	3 204	3 474	4 534	5 804	4 764	6 024	8 744	
PKTM III	180×1 000	3 354	3 624	4 684	5 954	4 914	6 174	8 895	

	Klapka	Rozměr (mm)	Provedení a cena v Kč							
			.41/.61	.50	.51	.60	.62	.80	.82	.83/.84
	PKTM III	160×160	15 303	6 078	12 698	8 818	10 839	2 807	3 747	5 047
	PKTM III	160×180	15 770	6 545	13 165	9 286	11 306	3 274	4 214	5 514
	PKTM III	160×200	15 351	6 126	12 746	8 866	10 887	2 854	3 794	5 094
	PKTM III	160×250	15 447	6 222	12 842	8 962	10 983	2 951	3 891	5 191
	PKTM III	160×280	15 482	6 257	12 877	8 997	11 018	2 986	3 926	5 226
	PKTM III	160×300	15 509	6 284	12 904	9 025	11 045	3 013	3 953	5 253
	PKTM III	160×315	15 527	6 302	12 922	9 042	11 063	3 031	3 971	5 271
	PKTM III	160×355	15 656	6 431	13 051	9 171	11 192	3 160	4 100	5 400
	PKTM III	160×400	15 713	6 488	13 108	9 228	11 249	3 217	4 157	5 457
	PKTM III	160×450	16 692	7 339	14 089	10 210	11 308	3 276	4 216	5 516
	PKTM III	160×500	16 754	7 401	14 152	10 272	11 370	3 338	4 278	5 578
	PKTM III	160×550	16 812	7 459	14 209	10 329	11 428	3 396	4 336	5 636
	PKTM III	160×560	16 824	7 471	14 222	10 342	11 441	3 408	4 348	5 648
	PKTM III	160×600	16 900	7 547	14 298	10 418	11 516	3 484	4 424	5 724
	PKTM III	160×630	16 935	7 582	14 332	10 452	11 551	3 519	4 459	5 759
	PKTM III	160×650	16 962	7 609	14 359	10 479	11 578	3 546	4 486	5 786
	PKTM III	160×710	17 035	7 682	14 432	10 553	11 651	3 619	4 559	5 859
	PKTM III	160×750	17 084	7 731	14 482	10 602	11 700	3 668	4 608	5 908
	PKTM III	160×800	17 144	7 791	14 541	10 661	11 760	3 728	4 668	5 968
	PKTM III	160×900	17 398	8 046	14 796	10 916	12 015	3 982	4 922	6 222
	PKTM III	160×1 000	17 543	8 190	14 941	11 061	12 159	4 127	5 067	6 367
	PKTM III	180×160	15 326	6 101	12 721	8 841	10 862	2 830	3 770	5 070
	PKTM III	180×180	15 351	6 126	12 746	8 866	10 887	2 855	3 795	5 095
	PKTM III	180×200	15 377	6 152	12 772	8 892	10 913	2 880	3 820	5 120
	PKTM III	180×250	15 473	6 248	12 868	8 988	11 009	2 977	3 917	5 217
	PKTM III	180×280	15 513	6 288	12 908	9 029	11 049	3 017	3 957	5 257
	PKTM III	180×300	15 541	6 316	12 936	9 056	11 077	3 045	3 985	5 285
	PKTM III	180×315	15 558	6 333	12 953	9 074	11 094	3 062	4 002	5 302
	PKTM III	180×355	15 690	6 465	13 085	9 206	11 226	3 194	4 134	5 434
	PKTM III	180×400	11 286	6 525	13 145	9 265	11 286	3 254	4 194	5 494
	PKTM III	180×450	16 735	7 382	14 132	10 253	11 351	3 319	4 259	5 559
	PKTM III	180×500	16 797	7 444	14 195	10 315	11 413	3 381	4 321	5 621
	PKTM III	180×550	16 860	7 507	14 258	10 378	11 477	3 444	4 384	5 684
	PKTM III	180×560	16 873	7 520	14 270	10 390	11 489	3 457	4 397	5 697
	PKTM III	180×600	16 949	7 596	14 346	10 467	11 565	3 533	4 473	5 773
	PKTM III	180×630	16 989	7 636	14 386	10 507	11 605	3 573	4 513	5 813
	PKTM III	180×650	17 016	7 663	14 413	10 534	11 632	3 600	4 540	5 840
	PKTM III	180×710	17 092	7 739	14 489	10 610	11 708	3 676	4 616	5 916
	PKTM III	180×750	17 144	7 791	14 541	10 662	11 760	3 728	4 668	5 968
	PKTM III	180×800	17 209	7 856	14 607	10 727	11 825	3 793	4 733	6 033
	PKTM III	180×900	17 470	8 117	14 867	10 987	12 086	4 054	4 994	6 294
	PKTM III	180×1 000	17 620	8 267	15 018	11 138	12 236	4 204	5 144	6 444

Požární klapky									
Klapka	Rozměr (mm)	Provedení a cena v Kč							
		.01	.11	.20	.21/22	.23	.24/25	.40	
PKTM III	200 × 160	2 001	2 271	3 331	4 601	3 561	4 821	6 233	
PKTM III	200 × 180	2 029	2 299	3 359	4 629	3 589	4 849	6 261	
PKTM III	200 × 200	2 054	2 324	3 384	4 654	3 614	4 874	6 287	
PKTM III	200 × 250	2 157	2 427	3 487	4 757	3 717	4 977	6 389	
PKTM III	200 × 280	2 197	2 467	3 527	4 797	3 757	5 017	6 429	
PKTM III	200 × 300	2 227	2 497	3 557	4 827	3 787	5 047	6 460	
PKTM III	200 × 315	2 245	2 515	3 575	4 845	3 805	5 065	6 477	
PKTM III	200 × 355	2 380	2 650	3 710	4 980	3 940	5 200	6 612	
PKTM III	200 × 400	2 442	2 712	3 772	5 042	4 002	5 262	6 674	
PKTM III	200 × 450	2 510	2 780	3 840	5 110	4 070	5 330	8 051	
PKTM III	200 × 500	2 578	2 848	3 908	5 178	4 138	5 398	8 119	
PKTM III	200 × 550	2 641	2 911	3 971	5 241	4 201	5 461	8 182	
PKTM III	200 × 560	2 656	2 926	3 986	5 256	4 216	5 476	8 197	
PKTM III	200 × 600	2 735	3 005	4 065	5 335	4 295	5 555	8 276	
PKTM III	200 × 630	2 775	3 045	4 105	5 375	4 335	5 595	8 316	
PKTM III	200 × 650	2 805	3 075	4 135	5 405	4 365	5 625	8 346	
PKTM III	200 × 710	2 884	3 154	4 214	5 484	4 444	5 704	8 425	
PKTM III	200 × 750	2 939	3 209	4 269	5 539	4 499	5 759	8 480	
PKTM III	200 × 800	3 062	3 332	4 392	5 662	4 622	5 882	8 603	
PKTM III	200 × 900	3 276	3 546	4 606	5 876	4 836	6 096	8 816	
PKTM III	200 × 1 000	3 429	3 699	4 759	6 029	4 989	6 249	8 970	
PKTM III	250 × 160	2 060	2 330	3 390	4 660	3 620	4 880	6 292	
PKTM III	250 × 180	2 091	2 361	3 421	4 691	3 651	4 911	6 323	
PKTM III	250 × 200	2 119	2 389	3 449	4 719	3 679	4 939	6 351	
PKTM III	250 × 250	2 229	2 499	3 559	4 829	3 789	5 049	6 462	
PKTM III	250 × 280	2 256	2 526	3 586	4 856	3 816	5 076	6 488	
PKTM III	250 × 300	2 306	2 576	3 636	4 906	3 866	5 126	6 538	
PKTM III	250 × 315	2 329	2 599	3 659	4 929	3 889	5 149	6 561	
PKTM III	250 × 355	2 469	2 739	3 799	5 069	4 029	5 289	6 702	
PKTM III	250 × 400	2 540	2 810	3 870	5 140	4 100	5 360	6 773	
PKTM III	250 × 450	2 614	2 884	3 944	5 214	4 174	5 434	8 155	
PKTM III	250 × 500	2 690	2 960	4 020	5 290	4 250	5 510	8 231	
PKTM III	250 × 550	2 788	3 058	4 118	5 388	4 348	5 608	8 328	
PKTM III	250 × 560	2 803	3 073	4 133	5 403	4 363	5 623	8 344	
PKTM III	250 × 600	2 864	3 134	4 194	5 464	4 424	5 684	8 405	
PKTM III	250 × 630	2 910	3 180	4 240	5 510	4 470	5 730	8 451	
PKTM III	250 × 650	2 943	3 213	4 273	5 543	4 503	5 763	8 484	
PKTM III	250 × 710	3 033	3 303	4 363	5 633	4 593	5 853	8 574	
PKTM III	250 × 750	3 149	3 419	4 479	5 749	4 709	5 969	8 690	
PKTM III	250 × 800	3 303	3 573	4 633	5 903	4 863	6 123	8 843	
PKTM III	250 × 900	3 453	3 723	4 783	6 053	5 013	6 273	8 994	
PKTM III	250 × 1 000	3 624	3 894	4 954	6 224	5 184	6 444	9 164	

	Klapka	Rozměr (mm)	Provedení a cena v Kč							
			.41/.61	.50	.51	.60	.62	.80	.82	.83/.84
	PKTM III	200 × 160	15 347	6 122	12 742	8 863	10 883	2 851	3 791	5 091
	PKTM III	200 × 180	15 375	6 150	12 770	8 891	10 911	2 879	3 819	5 119
	PKTM III	200 × 200	15 401	6 176	12 796	8 916	10 937	2 904	3 844	5 144
	PKTM III	200 × 250	15 503	6 278	12 898	9 018	11 039	3 007	3 947	5 247
	PKTM III	200 × 280	15 543	6 318	12 938	9 058	11 079	3 047	3 987	5 287
	PKTM III	200 × 300	15 574	6 349	12 969	9 089	11 110	3 077	4 017	5 317
	PKTM III	200 × 315	15 591	6 366	12 986	9 106	11 127	3 095	4 035	5 335
	PKTM III	200 × 355	15 726	6 501	13 121	9 241	11 262	3 230	4 170	5 470
	PKTM III	200 × 400	15 788	6 563	13 183	9 304	11 324	3 292	4 232	5 532
	PKTM III	200 × 450	16 776	7 423	14 173	10 294	11 392	3 360	4 300	5 600
	PKTM III	200 × 500	16 844	7 491	14 241	10 362	11 460	3 428	4 368	5 668
	PKTM III	200 × 550	16 907	7 554	14 304	10 425	11 523	3 491	4 431	5 731
	PKTM III	200 × 560	16 922	7 569	14 320	10 440	11 538	3 506	4 446	5 746
	PKTM III	200 × 600	17 001	7 648	14 399	10 519	11 617	3 585	4 525	5 825
	PKTM III	200 × 63	17 041	7 688	14 439	10 559	11 657	3 625	4 565	5 865
	PKTM III	200 × 650	17 071	7 718	14 469	10 589	11 687	3 655	4 595	5 895
	PKTM III	200 × 710	17 150	7 797	14 547	10 667	11 766	3 734	4 674	5 974
	PKTM III	200 × 750	17 205	7 852	14 602	10 722	11 821	3 789	4 729	6 029
	PKTM III	200 × 800	17 328	7 975	14 726	10 846	11 945	3 912	4 852	6 152
	PKTM III	200 × 900	17 542	8 189	14 939	11 059	12 158	4 126	5 066	6 366
	PKTM III	200 × 1000	17 695	8 342	15 093	11 213	12 311	4 279	5 219	6 519
	PKTM III	250 × 160	15 406	6 181	12 801	8 921	10 942	2 910	3 850	5 150
	PKTM III	250 × 180	15 437	6 212	12 832	8 952	10 973	2 941	3 881	5 181
	PKTM III	250 × 200	15 465	6 240	12 860	8 980	11 001	2 969	3 909	5 209
	PKTM III	250 × 250	15 576	6 351	12 971	9 091	11 112	3 079	4 019	5 319
	PKTM III	250 × 280	15 602	6 377	12 997	9 118	11 138	3 106	4 046	5 346
	PKTM III	250 × 300	15 652	6 427	13 047	9 167	11 188	3 156	4 096	5 396
	PKTM III	250 × 315	15 675	6 450	13 070	9 190	11 211	3 179	4 119	5 419
	PKTM III	250 × 355	15 816	6 591	13 211	9 331	11 352	3 319	4 259	5 559
	PKTM III	250 × 400	15 887	6 662	13 282	9 402	11 423	3 390	4 330	5 630
	PKTM III	250 × 450	16 880	7 527	14 277	10 397	11 496	3 464	4 404	5 704
	PKTM III	250 × 500	16 956	7 603	14 354	10 474	11 572	3 540	4 480	5 780
	PKTM III	250 × 550	17 054	7 701	14 451	10 571	10 571	3 638	4 578	5 878
	PKTM III	250 × 560	17 069	7 716	14 466	10 587	11 685	3 653	4 593	5 893
	PKTM III	250 × 600	17 130	7 777	14 528	10 648	11 746	3 714	4 654	5 954
	PKTM III	250 × 630	17 176	7 823	14 574	10 694	11 792	3 760	4 700	6 000
	PKTM III	250 × 650	17 209	7 856	14 606	10 726	11 825	3 793	4 733	6 033
	PKTM III	250 × 710	17 299	7 946	14 696	10 816	11 915	3 883	4 823	6 123
	PKTM III	250 × 750	17 415	8 062	14 812	10 933	12 031	3 999	4 939	6 239
	PKTM III	250 × 800	17 569	8 216	14 966	11 086	12 185	4 153	5 093	6 393
	PKTM III	250 × 900	17 719	8 366	15 116	11 236	12 335	4 303	5 243	6 543
	PKTM III	250 × 1000	17 890	8 537	15 287	11 407	12 506	4 474	5 414	6 714

Požární klapky									
Klapka	Rozměr (mm)	Provedení a cena v Kč							
		.01	.11	.20	.21/22	.23	.24/25	.40	
PKTM III	280 × 160	2 097	2 367	3 427	4 697	3 657	4 917	6 329	
PKTM III	280 × 180	2 128	2 398	3 458	4 728	3 688	4 948	6 360	
PKTM III	280 × 200	2 162	2 432	3 492	4 762	3 722	4 982	6 394	
PKTM III	280 × 250	2 275	2 545	3 605	4 875	3 835	5 095	6 507	
PKTM III	280 × 280	2 324	2 594	3 654	4 924	3 884	5 144	6 556	
PKTM III	280 × 300	2 357	2 627	3 687	4 957	3 917	5 177	6 589	
PKTM III	280 × 315	2 380	2 650	3 710	4 980	3 940	5 200	6 612	
PKTM III	280 × 355	2 526	2 796	3 856	5 126	4 086	5 346	6 758	
PKTM III	280 × 400	2 600	2 870	3 930	5 200	4 160	5 420	6 832	
PKTM III	280 × 450	2 679	2 949	4 009	5 279	4 239	5 499	8 220	
PKTM III	280 × 500	2 761	3 031	4 091	5 361	4 321	5 581	8 302	
PKTM III	280 × 550	2 861	3 131	4 191	5 461	4 421	5 681	8 402	
PKTM III	280 × 560	2 879	3 149	4 209	5 479	4 439	5 699	8 420	
PKTM III	280 × 600	2 944	3 214	4 274	5 544	4 504	5 764	8 484	
PKTM III	280 × 630	2 992	3 262	4 322	5 592	4 552	5 812	8 533	
PKTM III	280 × 650	3 028	3 298	4 358	5 628	4 588	5 848	8 568	
PKTM III	280 × 710	3 123	3 393	4 453	5 723	4 683	5 943	8 664	
PKTM III	280 × 750	3 320	3 590	4 650	5 920	4 880	6 140	8 860	
PKTM III	280 × 800	3 402	3 672	4 732	6 002	4 962	6 222	8 942	
PKTM III	280 × 900	3 560	3 830	4 890	6 160	5 120	6 380	9 101	
PKTM III	280 × 1 000	3 745	4 015	5 075	6 345	5 305	6 565	9 286	
PKTM III	300 × 160	2 122	2 392	3 452	4 722	3 682	4 942	6 355	
PKTM III	300 × 180	2 153	2 423	3 483	4 753	3 713	4 973	6 385	
PKTM III	300 × 200	2 187	2 457	3 517	4 787	3 747	5 007	6 419	
PKTM III	300 × 250	2 306	2 576	3 636	4 906	3 866	5 126	6 538	
PKTM III	300 × 280	2 355	2 625	3 685	4 955	3 915	5 175	6 587	
PKTM III	300 × 300	2 391	2 661	3 721	4 991	3 951	5 211	6 623	
PKTM III	300 × 315	2 417	2 687	3 747	5 017	3 977	5 237	6 649	
PKTM III	300 × 355	2 563	2 833	3 893	5 163	4 123	5 383	6 795	
PKTM III	300 × 400	2 639	2 909	3 969	5 239	4 199	5 459	6 872	
PKTM III	300 × 450	2 724	2 994	4 054	5 324	4 284	5 544	8 265	
PKTM III	300 × 500	2 806	3 076	4 136	5 406	4 366	5 626	8 347	
PKTM III	300 × 550	2 912	3 182	4 242	5 512	4 472	5 732	8 453	
PKTM III	300 × 560	2 930	3 200	4 260	5 530	4 490	5 750	8 471	
PKTM III	300 × 600	2 997	3 267	4 327	5 597	4 557	5 817	8 538	
PKTM III	300 × 630	3 049	3 319	4 379	5 649	4 609	5 869	8 589	
PKTM III	300 × 650	3 084	3 354	4 414	5 684	4 644	5 904	8 625	
PKTM III	300 × 710	3 315	3 585	4 645	5 915	4 875	6 135	8 856	
PKTM III	300 × 750	3 384	3 654	4 714	5 984	4 944	6 204	8 925	
PKTM III	300 × 800	3 466	3 736	4 796	6 066	5 026	6 286	9 007	
PKTM III	300 × 900	3 633	3 903	4 963	6 233	5 193	6 453	9 174	
PKTM III	300 × 1 000	3 821	4 091	5 151	6 421	5 381	6 641	9 362	

	Klapka	Rozměr (mm)	Provedení a cena v Kč							
			.41/.61	.50	.51	.60	.62	.80	.82	.83/.84
	PKTM III	280 × 160	15 443	6 218	12 838	8 958	10 979	2 947	3 887	5 187
	PKTM III	280 × 180	15 474	6 249	12 869	8 989	11 010	2 978	3 918	5 218
	PKTM III	280 × 200	15 508	6 283	12 903	9 023	11 044	3 012	3 952	5 252
	PKTM III	280 × 250	15 621	6 396	13 016	9 136	11 157	3 125	4 065	5 365
	PKTM III	280 × 280	15 670	6 445	13 065	9 185	11 206	3 174	4 114	5 414
	PKTM III	280 × 300	15 703	6 478	13 098	9 218	11 239	3 207	4 147	5 447
	PKTM III	280 × 315	15 726	6 501	13 121	9 241	11 262	3 230	4 170	5 470
	PKTM III	280 × 355	15 872	6 647	13 267	9 388	11 408	3 376	4 316	5 616
	PKTM III	280 × 400	15 946	6 721	13 341	9 461	11 482	3 450	4 390	5 690
	PKTM III	280 × 450	16 945	7 592	14 342	10 463	11 561	3 529	4 469	5 769
	PKTM III	280 × 500	17 027	7 674	14 424	10 545	11 643	3 611	4 551	5 851
	PKTM III	280 × 550	17 127	7 774	14 525	10 645	11 743	3 711	4 651	5 951
	PKTM III	280 × 560	17 145	7 792	14 543	10 663	11 762	3 729	4 669	5 969
	PKTM III	280 × 600	17 210	7 857	14 607	10 727	11 826	3 794	4 734	6 034
	PKTM III	280 × 630	17 258	7 905	14 656	10 776	11 874	3 842	4 782	6 082
	PKTM III	280 × 650	17 294	7 941	14 691	10 811	11 910	3 878	4 818	6 118
	PKTM III	280 × 710	17 389	8 036	14 787	10 907	12 005	3 973	4 913	6 213
	PKTM III	280 × 750	17 586	8 233	14 983	11 103	12 202	4 170	5 110	6 410
	PKTM III	280 × 800	17 668	8 315	15 065	11 185	12 284	4 252	5 192	6 492
	PKTM III	280 × 900	17 826	8 473	15 224	11 344	12 442	4 410	5 350	6 650
	PKTM III	280 × 1000	18 011	8 658	15 408	11 529	12 627	4 595	5 535	6 835
	PKTM III	300 × 160	15 469	6 244	12 864	8 984	11 005	2 972	3 912	5 212
	PKTM III	300 × 180	15 499	6 274	12 894	9 015	11 035	3 003	3 943	5 243
	PKTM III	300 × 200	15 533	6 308	12 928	9 048	11 069	3 037	3 977	5 277
	PKTM III	300 × 250	15 652	6 427	13 047	9 167	11 188	3 156	4 096	5 396
	PKTM III	300 × 280	15 701	6 476	13 096	9 216	11 237	3 205	4 145	5 445
	PKTM III	300 × 300	15 737	6 512	13 132	9 252	11 273	3 241	4 181	5 481
	PKTM III	300 × 315	15 763	6 538	13 158	9 278	11 299	3 267	4 207	5 507
	PKTM III	300 × 355	15 909	6 684	13 304	9 424	11 445	3 413	4 353	5 653
	PKTM III	300 × 400	15 986	6 761	13 381	9 501	11 522	3 489	4 429	5 729
	PKTM III	300 × 450	16 990	7 637	14 388	10 508	11 606	3 574	4 514	5 814
	PKTM III	300 × 500	17 072	7 719	14 469	10 590	11 688	3 656	4 596	5 896
	PKTM III	300 × 550	17 178	7 825	14 575	10 696	11 794	3 762	4 702	6 002
	PKTM III	300 × 560	17 196	7 843	14 594	10 714	11 812	3 780	4 720	6 020
	PKTM III	300 × 600	17 263	7 910	14 661	10 781	11 879	3 847	4 787	6 087
	PKTM III	300 × 630	17 315	7 962	14 712	10 832	11 931	3 899	4 839	6 139
	PKTM III	300 × 650	17 350	7 997	14 747	10 868	11 966	3 934	4 874	6 174
	PKTM III	300 × 710	17 581	8 228	14 979	11 099	12 197	4 165	5 105	6 405
	PKTM III	300 × 750	17 650	8 297	15 048	11 168	12 266	4 234	5 174	6 474
	PKTM III	300 × 800	17 732	8 380	15 130	11 250	12 349	4 316	5 256	6 556
	PKTM III	300 × 900	17 899	8 546	15 297	11 417	12 516	4 483	5 423	6 723
	PKTM III	300 × 1000	18 087	8 735	15 485	11 605	12 704	4 671	5 611	6 911

Požární klapky									
Klapka	Rozměr (mm)	Provedení a cena v Kč							
		.01	.11	.20	.21/22	.23	.24/25	.40	
PKTM III	315 × 160	2 147	2 417	3 477	4 747	3 707	4 967	6 379	
PKTM III	315 × 180	2 180	2 450	3 510	4 780	3 740	5 000	6 413	
PKTM III	315 × 200	2 214	2 484	3 544	4 814	3 774	5 034	6 447	
PKTM III	315 × 250	2 333	2 603	3 663	4 933	3 893	5 153	6 566	
PKTM III	315 × 280	2 385	2 655	3 715	4 985	3 945	5 205	6 617	
PKTM III	315 × 300	2 475	2 745	3 805	5 075	4 035	5 295	6 707	
PKTM III	315 × 315	2 447	2 717	3 777	5 047	4 007	5 267	6 679	
PKTM III	315 × 355	2 596	2 866	3 926	5 196	4 156	5 416	6 828	
PKTM III	315 × 400	2 675	2 945	4 005	5 275	4 235	5 495	6 908	
PKTM III	315 × 450	2 763	3 033	4 093	5 363	4 323	5 583	8 304	
PKTM III	315 × 500	2 848	3 118	4 178	5 448	4 408	5 668	8 388	
PKTM III	315 × 550	2 954	3 224	4 284	5 554	4 514	5 774	8 494	
PKTM III	315 × 560	2 972	3 242	4 302	5 572	4 532	5 792	8 512	
PKTM III	315 × 600	3 044	3 314	4 374	5 644	4 604	5 864	8 585	
PKTM III	315 × 630	3 096	3 366	4 426	5 696	4 656	5 916	8 636	
PKTM III	315 × 650	3 131	3 401	4 461	5 731	4 691	5 951	8 672	
PKTM III	315 × 710	3 365	3 635	4 695	5 965	4 925	6 185	8 906	
PKTM III	315 × 750	3 437	3 707	4 767	6 037	4 997	6 257	8 978	
PKTM III	315 × 800	3 522	3 792	4 852	6 122	5 082	6 342	9 063	
PKTM III	315 × 900	3 695	3 965	5 025	6 295	5 255	6 515	9 235	
PKTM III	315 × 1 000	3 895	4 165	5 225	6 495	5 455	6 715	9 435	
PKTM III	355 × 160	2 188	2 458	3 518	4 788	3 748	5 008	6 420	
PKTM III	355 × 180	2 225	2 495	3 555	4 825	3 785	5 045	6 457	
PKTM III	355 × 200	2 261	2 531	3 591	4 861	3 821	5 081	6 493	
PKTM III	355 × 250	2 389	2 659	3 719	4 989	3 949	5 209	6 621	
PKTM III	355 × 280	2 443	2 713	3 773	5 043	4 003	5 263	6 675	
PKTM III	355 × 300	2 482	2 752	3 812	5 082	4 042	5 302	6 714	
PKTM III	355 × 315	2 344	2 614	3 674	4 944	3 904	5 164	6 577	
PKTM III	355 × 355	2 665	2 935	3 995	5 265	4 225	5 485	6 897	
PKTM III	355 × 400	2 750	3 020	4 080	5 350	4 310	5 570	6 983	
PKTM III	355 × 450	2 841	3 111	4 171	5 441	4 401	5 661	8 381	
PKTM III	355 × 500	2 934	3 204	4 264	5 534	4 494	5 754	8 475	
PKTM III	355 × 550	3 048	3 318	4 378	5 648	4 608	5 868	8 589	
PKTM III	355 × 560	3 066	3 336	4 396	5 666	4 626	5 886	8 607	
PKTM III	355 × 600	3 142	3 412	4 472	5 742	4 702	5 962	8 683	
PKTM III	355 × 630	3 199	3 469	4 529	5 799	4 759	6 019	8 740	
PKTM III	355 × 650	3 370	3 640	4 700	5 970	4 930	6 190	8 911	
PKTM III	355 × 710	3 480	3 750	4 810	6 080	5 040	6 300	9 021	
PKTM III	355 × 750	3 554	3 824	4 884	6 154	5 114	6 374	9 095	
PKTM III	355 × 800	3 648	3 918	4 978	6 248	5 208	6 468	9 189	
PKTM III	355 × 900	3 832	4 102	5 162	6 432	5 392	6 652	9 372	
PKTM III	355 × 1 000	4 040	4 310	5 370	6 640	5 600	6 860	9 581	

	Klapka	Rozměr (mm)	Provedení a cena v Kč							
			.41/.61	.50	.51	.60	.62	.80	.82	.83/.84
	PKTM III	315 × 160	15 493	6 268	12 888	9 008	11 029	2 997	3 937	5 237
	PKTM III	315 × 180	15 527	6 302	12 922	9 042	11 063	3 030	3 970	5 270
	PKTM III	315 × 200	15 561	6 336	12 955	9 076	11 096	3 064	4 004	5 304
	PKTM III	315 × 250	15 680	6 455	13 075	9 195	11 216	3 183	4 123	5 423
	PKTM III	315 × 280	15 731	6 506	13 126	9 246	11 267	3 235	4 175	5 475
	PKTM III	315 × 300	15 821	6 596	13 216	9 336	11 357	3 325	4 265	5 565
	PKTM III	315 × 315	15 793	6 568	13 188	9 308	11 329	3 297	4 237	5 537
	PKTM III	315 × 355	15 942	6 717	13 337	9 457	11 478	3 446	4 386	5 686
	PKTM III	315 × 400	16 021	6 797	13 416	9 537	11 557	3 525	4 465	5 765
	PKTM III	315 × 450	17 029	7 676	14 426	10 546	11 645	3 613	4 553	5 853
	PKTM III	315 × 500	17 114	7 761	14 511	10 631	11 730	3 698	4 638	5 938
	PKTM III	315 × 550	17 220	7 867	14 617	10 737	11 836	3 804	4 744	6 044
	PKTM III	315 × 560	17 238	7 885	14 635	10 755	11 854	3 822	4 762	6 062
	PKTM III	315 × 600	17 310	7 957	14 708	10 828	11 926	3 894	4 834	6 134
	PKTM III	315 × 630	17 362	8 009	14 759	10 879	11 978	3 946	4 886	6 186
	PKTM III	315 × 650	17 397	8 044	14 795	10 915	12 013	3 981	4 921	6 221
	PKTM III	315 × 710	17 631	8 278	15 029	11 149	12 247	4 215	5 155	6 455
	PKTM III	315 × 750	17 703	8 350	15 101	11 221	12 319	4 287	5 227	6 527
	PKTM III	315 × 800	17 788	8 435	15 186	11 306	12 404	4 372	5 312	6 612
	PKTM III	315 × 900	17 961	8 608	15 358	11 478	12 577	4 545	5 485	6 785
	PKTM III	315 × 1 000	18 161	8 808	15 558	11 678	12 777	4 745	5 685	6 985
	PKTM III	355 × 160	15 534	6 309	12 929	9 050	11 070	3 038	3 978	5 278
	PKTM III	355 × 180	15 571	6 346	12 966	9 086	11 107	3 075	4 015	5 315
	PKTM III	355 × 200	15 607	6 382	13 002	9 123	11 143	3 111	4 051	5 351
	PKTM III	355 × 250	15 735	6 510	13 130	9 250	11 271	3 239	4 179	5 479
	PKTM III	355 × 280	15 789	6 564	13 184	9 304	11 325	3 293	4 233	5 533
	PKTM III	355 × 300	15 828	6 603	13 223	9 343	11 364	3 332	4 272	5 572
	PKTM III	355 × 315	15 691	6 466	13 086	9 206	11 227	3 194	4 134	5 434
	PKTM III	355 × 355	16 011	6 786	13 406	9 527	11 547	3 515	4 455	5 755
	PKTM III	355 × 400	16 096	6 871	13 491	9 612	11 632	3 600	4 540	5 840
	PKTM III	355 × 450	17 107	7 754	14 504	10 624	11 723	3 691	4 631	5 931
	PKTM III	355 × 500	17 200	7 847	14 597	10 717	11 816	3 784	4 724	6 024
	PKTM III	355 × 550	17 314	7 961	14 712	10 832	11 930	3 898	4 838	6 138
	PKTM III	355 × 560	17 332	7 980	14 730	10 850	11 949	3 916	4 856	6 156
	PKTM III	355 × 600	17 408	8 055	14 805	10 925	12 024	3 992	4 932	6 232
	PKTM III	355 × 630	17 465	8 112	14 862	10 983	12 081	4 049	4 989	6 289
	PKTM III	355 × 650	17 636	8 283	15 033	11 154	12 252	4 220	5 160	6 460
	PKTM III	355 × 710	17 746	8 393	15 143	11 263	12 362	4 330	5 270	6 570
	PKTM III	355 × 750	17 820	8 467	15 218	11 338	12 437	4 404	5 344	6 644
	PKTM III	355 × 800	17 914	8 561	15 311	11 431	12 530	4 498	5 438	6 738
	PKTM III	355 × 900	18 098	8 745	15 495	11 615	12 714	4 682	5 622	6 922
	PKTM III	355 × 1 000	18 306	8 953	15 703	11 823	12 922	4 890	5 830	7 130

Požární klapky									
Klapka	Rozměr (mm)	Provedení a cena v Kč							
		.01	.11	.20	.21/22	.23	.24/25	.40	
PKTM III	400 × 160	2 245	2 515	3 575	4 845	3 805	5 065	6 478	
PKTM III	400 × 180	2 285	2 555	3 615	4 885	3 845	5 105	6 517	
PKTM III	400 × 200	2 324	2 594	3 654	4 924	3 884	5 144	6 556	
PKTM III	400 × 250	2 457	2 727	3 787	5 057	4 017	5 277	6 689	
PKTM III	400 × 280	2 520	2 790	3 850	5 120	4 080	5 340	6 752	
PKTM III	400 × 300	2 562	2 832	3 892	5 162	4 122	5 382	6 794	
PKTM III	400 × 315	2 591	2 861	3 921	5 191	4 151	5 411	6 823	
PKTM III	400 × 355	2 751	3 021	4 081	5 351	4 311	5 571	6 983	
PKTM III	400 × 400	2 841	3 111	4 171	5 441	4 401	5 661	7 074	
PKTM III	400 × 450	2 963	3 233	4 293	5 563	4 523	5 783	8 504	
PKTM III	400 × 500	3 065	3 335	4 395	5 665	4 625	5 885	8 606	
PKTM III	400 × 550	3 162	3 432	4 492	5 762	4 722	5 982	8 703	
PKTM III	400 × 560	3 183	3 453	4 513	5 783	4 743	6 003	8 724	
PKTM III	400 × 600	3 320	3 590	4 650	5 920	4 880	6 140	8 860	
PKTM III	400 × 630	3 457	3 727	4 787	6 057	5 017	6 277	8 997	
PKTM III	400 × 650	3 498	3 768	4 828	6 098	5 058	6 318	9 039	
PKTM III	400 × 710	3 619	3 889	4 949	6 219	5 179	6 439	9 160	
PKTM III	400 × 750	3 699	3 969	5 029	6 299	5 259	6 519	9 240	
PKTM III	400 × 800	3 798	4 068	5 128	6 398	5 358	6 618	9 339	
PKTM III	400 × 900	3 996	4 266	5 326	6 596	5 556	6 816	9 537	
PKTM III	400 × 1 000	4 219	4 489	5 549	6 819	5 779	7 039	9 759	
PKTM III	450 × 160	2 308	2 578	3 638	4 908	3 868	5 128	6 540	
PKTM III	450 × 180	2 350	2 620	3 680	4 950	3 910	5 170	6 582	
PKTM III	450 × 200	2 392	2 662	3 722	4 992	3 952	5 212	6 624	
PKTM III	450 × 250	2 534	2 804	3 864	5 134	4 094	5 354	6 766	
PKTM III	450 × 280	2 599	2 869	3 929	5 199	4 159	5 419	6 832	
PKTM III	450 × 300	2 644	2 914	3 974	5 244	4 204	5 464	6 876	
PKTM III	450 × 315	2 675	2 945	4 005	5 275	4 235	5 495	6 908	
PKTM III	450 × 355	2 844	3 114	4 174	5 444	4 404	5 664	7 076	
PKTM III	450 × 400	2 943	3 213	4 273	5 543	4 503	5 763	7 175	
PKTM III	450 × 450	3 073	3 343	4 403	5 673	4 633	5 893	8 614	
PKTM III	450 × 500	3 181	3 451	4 511	5 781	4 741	6 001	8 722	
PKTM III	450 × 550	3 342	3 612	4 672	5 942	4 902	6 162	8 883	
PKTM III	450 × 560	3 443	3 713	4 773	6 043	5 003	6 263	8 984	
PKTM III	450 × 600	3 530	3 800	4 860	6 130	5 090	6 350	9 070	
PKTM III	450 × 630	3 595	3 865	4 925	6 195	5 155	6 415	9 136	
PKTM III	450 × 650	3 639	3 909	4 969	6 239	5 199	6 459	9 180	
PKTM III	450 × 710	3 768	4 038	5 098	6 368	5 328	6 588	9 309	
PKTM III	450 × 750	3 854	4 124	5 184	6 454	5 414	6 674	9 395	
PKTM III	450 × 800	3 962	4 232	5 292	6 562	5 522	6 782	9 503	
PKTM III	450 × 900	4 180	4 450	5 510	6 780	5 740	7 000	9 720	
PKTM III	450 × 1 000	4 416	4 686	5 746	7 016	5 976	7 236	9 957	

	Klapka	Rozměr (mm)	Provedení a cena v Kč							
			.41/.61	.50	.51	.60	.62	.80	.82	.83/.84
	PKTM III	400 × 160	15 592	6 367	12 987	9 107	11 128	3 095	4 035	5 335
	PKTM III	400 × 180	15 631	6 406	13 026	9 146	11 167	3 135	4 075	5 375
	PKTM III	400 × 200	15 670	6 445	13 065	9 186	11 206	3 174	4 114	5 414
	PKTM III	400 × 250	15 803	6 578	13 198	9 319	11 339	3 307	4 247	5 547
	PKTM III	400 × 280	15 866	6 641	13 261	9 382	11 402	3 370	4 310	5 610
	PKTM III	400 × 300	15 908	6 683	13 303	9 423	11 444	3 412	4 352	5 652
	PKTM III	400 × 315	15 937	6 712	13 332	9 452	11 473	3 441	4 381	5 681
	PKTM III	400 × 355	16 097	6 872	13 492	9 612	11 633	3 601	4 541	5 841
	PKTM III	400 × 400	16 188	6 963	13 583	9 703	11 724	3 691	4 631	5 931
	PKTM III	400 × 450	17 229	7 876	14 627	10 747	11 845	3 813	4 753	6 053
	PKTM III	400 × 500	17 331	7 978	14 728	10 849	11 947	3 915	4 855	6 155
	PKTM III	400 × 550	17 428	8 075	14 825	10 946	12 044	4 012	4 952	6 252
	PKTM III	400 × 560	17 449	8 096	14 846	10 967	12 065	4 033	4 973	6 273
	PKTM III	400 × 600	17 586	8 233	14 983	11 103	12 202	4 170	5 110	6 410
	PKTM III	400 × 630	17 723	8 370	15 120	11 240	12 339	4 307	5 247	6 547
	PKTM III	400 × 650	17 764	8 411	15 161	11 281	12 380	4 348	5 288	6 588
	PKTM III	400 × 710	17 885	8 532	15 282	11 402	12 501	4 469	5 409	6 709
	PKTM III	400 × 750	17 965	8 612	15 363	11 483	12 581	4 549	5 489	6 789
	PKTM III	400 × 800	18 064	8 711	15 462	11 582	12 680	4 648	5 588	6 888
	PKTM III	400 × 900	18 262	8 909	15 660	11 780	12 878	4 846	5 786	7 086
	PKTM III	400 × 1 000	18 485	9 132	15 882	12 002	13 101	5 069	6 009	7 309
	PKTM III	450 × 160	15 654	6 429	13 049	9 169	11 190	3 158	4 098	5 398
	PKTM III	450 × 180	15 696	6 471	13 091	9 211	11 232	3 200	4 140	5 440
	PKTM III	450 × 200	15 738	6 513	13 133	9 253	11 274	3 242	4 182	5 482
	PKTM III	450 × 250	15 880	6 655	13 275	9 395	11 416	3 384	4 324	5 624
	PKTM III	450 × 280	15 945	6 720	13 340	9 461	11 481	3 449	4 389	5 689
	PKTM III	450 × 300	15 990	6 765	13 385	9 505	11 526	3 494	4 434	5 734
	PKTM III	450 × 315	16 022	6 797	13 417	9 537	11 558	3 525	4 465	5 765
	PKTM III	450 × 355	16 190	6 965	13 585	9 705	11 726	3 694	4 634	5 934
	PKTM III	450 × 400	16 289	7 064	13 684	9 805	11 825	3 793	4 733	6 033
	PKTM III	450 × 450	17 339	7 987	14 737	10 857	11 956	3 923	4 863	6 163
	PKTM III	450 × 500	17 447	8 094	14 844	10 964	12 063	4 031	4 971	6 271
	PKTM III	450 × 550	17 608	8 255	15 005	11 125	12 224	4 192	5 132	6 432
	PKTM III	450 × 560	17 709	8 356	15 106	11 226	12 325	4 293	5 233	6 533
	PKTM III	450 × 600	17 796	8 443	15 193	11 313	12 412	4 380	5 320	6 620
	PKTM III	450 × 630	17 861	8 508	15 258	11 379	12 477	4 445	5 385	6 685
	PKTM III	450 × 650	17 905	8 552	15 302	11 423	12 521	4 489	5 429	6 729
	PKTM III	450 × 710	18 034	8 681	15 432	11 552	12 651	4 618	5 558	6 858
	PKTM III	450 × 750	18 120	8 767	15 518	11 638	12 737	4 704	5 644	6 944
	PKTM III	450 × 800	18 228	8 875	15 625	11 746	12 844	4 812	5 752	7 052
	PKTM III	450 × 900	18 446	9 093	15 843	11 963	13 062	5 030	5 970	7 270
	PKTM III	450 × 1 000	18 683	9 330	16 080	12 200	13 299	5 266	6 206	7 506

Požární klapky									
Klapka	Rozměr (mm)	Provedení a cena v Kč							
		.01	.11	.20	.21/22	.23	.24/25	.40	
PKTM III	500 × 160	2 368	2 638	3 698	4 968	3 928	5 188	6 600	
PKTM III	500 × 180	2 415	2 685	3 745	5 015	3 975	5 235	6 647	
PKTM III	500 × 200	2 460	2 730	3 790	5 060	4 020	5 280	6 692	
PKTM III	500 × 250	2 610	2 880	3 940	5 210	4 170	5 430	6 843	
PKTM III	500 × 280	2 682	2 952	4 012	5 282	4 242	5 502	6 914	
PKTM III	500 × 300	2 729	2 999	4 059	5 329	4 289	5 549	6 961	
PKTM III	500 × 315	2 763	3 033	4 093	5 363	4 323	5 583	6 996	
PKTM III	500 × 355	2 938	3 208	4 268	5 538	4 498	5 758	7 170	
PKTM III	500 × 400	3 065	3 335	4 395	5 665	4 625	5 885	7 298	
PKTM III	500 × 450	3 181	3 451	4 511	5 781	4 741	6 001	8 722	
PKTM III	500 × 500	3 297	3 567	4 627	5 897	4 857	6 117	8 838	
PKTM III	500 × 550	3 544	3 814	4 874	6 144	5 104	6 364	9 084	
PKTM III	500 × 560	3 567	3 837	4 897	6 167	5 127	6 387	9 108	
PKTM III	500 × 600	3 663	3 933	4 993	6 263	5 223	6 483	9 203	
PKTM III	500 × 630	3 734	4 004	5 064	6 334	5 294	6 554	9 275	
PKTM III	500 × 650	3 780	4 050	5 110	6 380	5 340	6 600	9 321	
PKTM III	500 × 710	3 918	4 188	5 248	6 518	5 478	6 738	9 459	
PKTM III	500 × 750	4 013	4 283	5 343	6 613	5 573	6 833	9 554	
PKTM III	500 × 800	4 129	4 399	5 459	6 729	5 689	6 949	9 670	
PKTM III	500 × 900	4 361	4 631	5 691	6 961	5 921	7 181	9 901	
PKTM III	500 × 1 000	4 583	4 853	5 913	7 183	6 143	7 403	10 124	
PKTM III	550 × 160	2 433	2 703	3 763	5 033	3 993	5 253	7 973	
PKTM III	550 × 180	2 483	2 753	3 813	5 083	4 043	5 303	8 024	
PKTM III	550 × 200	2 531	2 801	3 861	5 131	4 091	5 351	8 072	
PKTM III	550 × 250	2 689	2 959	4 019	5 289	4 249	5 509	8 230	
PKTM III	550 × 280	2 764	3 034	4 094	5 364	4 324	5 584	8 304	
PKTM III	550 × 300	2 817	3 087	4 147	5 417	4 377	5 637	8 357	
PKTM III	550 × 315	2 851	3 121	4 181	5 451	4 411	5 671	8 392	
PKTM III	550 × 355	3 034	3 304	4 364	5 634	4 594	5 854	8 574	
PKTM III	550 × 400	3 170	3 440	4 500	5 770	4 730	5 990	8 711	
PKTM III	550 × 450	3 347	3 617	4 677	5 947	4 907	6 167	8 888	
PKTM III	550 × 500	3 548	3 818	4 878	6 148	5 108	6 368	9 089	
PKTM III	550 × 550	3 671	3 941	5 001	6 271	5 231	6 491	9 211	
PKTM III	550 × 560	3 697	3 967	5 027	6 297	5 257	6 517	9 238	
PKTM III	550 × 600	3 798	4 068	5 128	6 398	5 358	6 618	9 339	
PKTM III	550 × 630	3 872	4 142	5 202	6 472	5 432	6 692	9 413	
PKTM III	550 × 650	3 924	4 194	5 254	6 524	5 484	6 744	9 465	
PKTM III	550 × 710	4 071	4 341	5 401	6 671	5 631	6 891	9 611	
PKTM III	550 × 750	4 174	4 444	5 504	6 774	5 734	6 994	9 714	
PKTM III	550 × 800	4 295	4 565	5 625	6 895	5 855	7 115	9 836	
PKTM III	550 × 900	4 544	4 814	5 874	7 144	6 104	7 364	10 085	
PKTM 90	550 × 1 000	5 545	5 815	6 875	8 145	7 105	8 365	11 873	

	Klapka	Rozměr (mm)	Provedení a cena v Kč							
			.41/.61	.50	.51	.60	.62	.80	.82	.83/.84
	PKTM III	500×160	15 714	6 489	13 109	9 229	11 250	3 218	4 158	5 458
	PKTM III	500×180	15 761	6 536	13 156	9 277	11 297	3 265	4 205	5 505
	PKTM III	500×200	15 806	6 581	13 201	9 322	11 342	3 310	4 250	5 550
	PKTM III	500×250	15 956	6 731	13 351	9 472	11 492	3 460	4 400	5 700
	PKTM III	500×280	16 028	6 803	13 423	9 543	11 564	3 532	4 472	5 772
	PKTM III	500×300	16 075	6 850	13 470	9 590	11 611	3 579	4 519	5 819
	PKTM III	500×315	16 110	6 885	13 505	9 625	11 646	3 613	4 553	5 853
	PKTM III	500×355	16 284	7 059	13 679	9 799	11 820	3 788	4 728	6 028
	PKTM III	500×400	16 412	7 187	13 807	9 927	11 948	3 915	4 855	6 155
	PKTM III	500×450	17 447	8 094	14 845	10 965	12 063	4 031	4 971	6 271
	PKTM III	500×500	17 563	8 210	14 960	11 081	12 179	4 147	5 087	6 387
	PKTM III	500×550	17 810	8 457	15 207	11 327	12 426	4 394	5 334	6 634
	PKTM III	500×560	17 833	8 480	15 231	11 351	12 450	4 417	5 357	6 657
	PKTM III	500×600	17 929	8 576	15 326	11 446	12 545	4 513	5 453	6 753
	PKTM III	500×630	18 000	8 647	15 397	11 517	12 616	4 584	5 524	6 824
	PKTM III	500×650	18 046	8 694	15 444	11 564	12 663	4 630	5 570	6 870
	PKTM III	500×710	18 184	8 831	15 582	11 702	12 800	4 768	5 708	7 008
	PKTM III	500×750	18 279	8 926	15 676	11 796	12 895	4 863	5 803	7 103
	PKTM III	500×800	18 395	9 042	15 792	11 912	13 011	4 979	5 919	7 219
	PKTM III	500×900	18 627	9 274	16 024	12 144	13 243	5 211	6 151	7 451
	PKTM III	500×1 000	18 849	9 496	16 247	12 367	13 466	5 433	6 373	7 673
	PKTM III	550×160	16 699	7 346	14 096	10 216	11 315	3 283	4 223	5 523
	PKTM III	550×180	16 749	7 396	14 146	10 267	11 365	3 333	4 273	5 573
	PKTM III	550×200	16 797	7 444	14 194	10 315	11 413	3 381	4 321	5 621
	PKTM III	550×250	16 955	7 602	14 353	10 473	11 572	3 539	4 479	5 779
	PKTM III	550×280	17 030	7 677	14 427	10 547	11 646	3 614	4 554	5 854
	PKTM III	550×300	17 083	7 730	14 480	10 600	11 699	3 667	4 607	5 907
	PKTM III	550×315	17 117	7 764	14 514	10 635	11 733	3 701	4 641	5 941
	PKTM III	550×355	17 300	7 947	14 697	10 817	11 916	3 884	4 824	6 124
	PKTM III	550×400	17 436	8 083	14 833	10 954	12 052	4 020	4 960	6 260
	PKTM III	550×450	17 613	8 260	15 010	11 130	12 229	4 197	5 137	6 437
	PKTM III	550×500	17 814	8 461	15 212	11 332	12 430	4 398	5 338	6 638
	PKTM III	550×550	17 937	8 584	15 334	11 454	12 553	4 521	5 461	6 761
	PKTM III	550×560	17 963	8 610	15 361	11 481	12 579	4 547	5 487	6 787
	PKTM III	550×600	18 064	8 711	15 461	11 582	12 680	4 648	5 588	6 888
	PKTM III	550×630	18 138	8 785	15 535	11 656	12 754	4 722	5 662	6 962
	PKTM III	550×650	18 190	8 837	15 588	11 708	12 807	4 774	5 714	7 014
	PKTM III	550×710	18 337	8 984	15 734	11 854	12 953	4 921	5 861	7 161
	PKTM III	550×750	18 440	9 087	15 837	11 957	13 056	5 024	5 964	7 264
	PKTM III	550×800	18 561	9 208	15 959	12 079	13 177	5 145	6 085	7 385
	PKTM III	550×900	18 810	9 457	16 207	12 328	13 426	5 394	6 334	7 634
	PKTM 90	550×1 000	19 811	11 001	17 208	14 176	15 612	6 395	7 335	8 635

Požární klapky									
Klapka	Rozměr (mm)	Provedení a cena v Kč							
		.01	.11	.20	.21/22	.23	.24/25	.40	
PKTM III	560 × 160	2 442	2 712	3 772	5 042	4 002	5 262	7 983	
PKTM III	560 × 180	2 492	2 762	3 822	5 092	4 052	5 312	8 033	
PKTM III	560 × 200	2 543	2 813	3 873	5 143	4 103	5 363	8 084	
PKTM III	560 × 250	2 701	2 971	4 031	5 301	4 261	5 521	8 242	
PKTM III	560 × 280	2 778	3 048	4 108	5 378	4 338	5 598	8 319	
PKTM III	560 × 300	2 831	3 101	4 161	5 431	4 391	5 651	8 372	
PKTM III	560 × 315	2 869	3 139	4 199	5 469	4 429	5 689	8 409	
PKTM III	560 × 355	3 049	3 319	4 379	5 649	4 609	5 869	8 589	
PKTM III	560 × 400	3 188	3 458	4 518	5 788	4 748	6 008	8 728	
PKTM III	560 × 450	3 445	3 715	4 775	6 045	5 005	6 265	8 985	
PKTM III	560 × 500	3 572	3 842	4 902	6 172	5 132	6 392	9 112	
PKTM III	560 × 550	3 694	3 964	5 024	6 294	5 254	6 514	9 235	
PKTM III	560 × 560	3 721	3 991	5 051	6 321	5 281	6 541	9 261	
PKTM III	560 × 600	3 821	4 091	5 151	6 421	5 381	6 641	9 362	
PKTM III	560 × 630	3 898	4 168	5 228	6 498	5 458	6 718	9 439	
PKTM III	560 × 650	3 950	4 220	5 280	6 550	5 510	6 770	9 491	
PKTM III	560 × 710	4 100	4 370	5 430	6 700	5 660	6 920	9 641	
PKTM III	560 × 750	4 203	4 473	5 533	6 803	5 763	7 023	9 743	
PKTM III	560 × 800	4 327	4 597	5 657	6 927	5 887	7 147	9 868	
PKTM 90	560 × 900	5 166	5 436	6 496	7 766	6 726	7 986	11 493	
PKTM 90	560 × 1 000	5 588	5 858	6 918	8 188	7 148	8 408	11 916	
PKTM III	600 × 160	2 495	2 765	3 825	5 095	4 055	5 315	8 036	
PKTM III	600 × 180	2 545	2 815	3 875	5 145	4 105	5 365	8 086	
PKTM III	600 × 200	2 599	2 869	3 929	5 199	4 159	5 419	8 140	
PKTM III	600 × 250	2 766	3 036	4 096	5 366	4 326	5 586	8 307	
PKTM III	600 × 280	2 846	3 116	4 176	5 446	4 406	5 666	8 386	
PKTM III	600 × 300	2 899	3 169	4 229	5 499	4 459	5 719	8 439	
PKTM III	600 × 315	2 939	3 209	4 269	5 539	4 499	5 759	8 479	
PKTM III	600 × 355	3 124	3 394	4 454	5 724	4 684	5 944	8 665	
PKTM III	600 × 400	3 324	3 594	4 654	5 924	4 884	6 144	8 865	
PKTM III	600 × 450	3 534	3 804	4 864	6 134	5 094	6 354	9 075	
PKTM III	600 × 500	3 664	3 934	4 994	6 264	5 224	6 484	9 205	
PKTM III	600 × 550	3 795	4 065	5 125	6 395	5 355	6 615	9 336	
PKTM III	600 × 560	3 824	4 094	5 154	6 424	5 384	6 644	9 365	
PKTM III	600 × 600	3 931	4 201	5 261	6 531	5 491	6 751	9 472	
PKTM III	600 × 630	4 010	4 280	5 340	6 610	5 570	6 830	9 551	
PKTM III	600 × 650	4 066	4 336	5 396	6 666	5 626	6 886	9 606	
PKTM III	600 × 710	4 223	4 493	5 553	6 823	5 783	7 043	9 764	
PKTM III	600 × 750	4 329	4 599	5 659	6 929	5 889	7 149	9 870	
PKTM III	600 × 800	4 462	4 732	5 792	7 062	6 022	7 282	10 003	
PKTM 90	600 × 900	5 463	5 733	6 793	8 063	7 023	8 283	11 790	
PKTM 90	600 × 1 000	5 758	6 028	7 088	8 358	7 318	8 578	12 086	

	Klapka	Rozměr (mm)	Provedení a cena v Kč							
			.41/.61	.50	.51	.60	.62	.80	.82	.83/.84
	PKTM III	560 × 160	16 708	7 355	14 105	10 226	11 324	3 292	4 232	5 532
	PKTM III	560 × 180	16 758	7 405	14 156	10 276	11 374	3 342	4 282	5 582
	PKTM III	560 × 200	16 809	7 456	14 206	10 327	11 425	3 393	4 333	5 633
	PKTM III	560 × 250	16 967	7 614	14 365	10 485	11 584	3 551	4 491	5 791
	PKTM III	560 × 280	17 044	7 691	14 442	10 562	11 661	3 628	4 568	5 868
	PKTM III	560 × 300	17 097	7 744	14 495	10 615	11 714	3 681	4 621	5 921
	PKTM III	560 × 315	17 135	7 782	14 532	10 652	11 751	3 719	4 659	5 959
	PKTM III	560 × 355	17 315	7 962	14 712	10 832	11 931	3 899	4 839	6 139
	PKTM III	560 × 400	17 454	8 101	14 851	10 971	12 070	4 038	4 978	6 278
	PKTM III	560 × 450	17 711	8 358	15 108	11 228	12 327	4 295	5 235	6 535
	PKTM III	560 × 500	17 838	8 485	15 235	11 355	12 454	4 422	5 362	6 662
	PKTM III	560 × 550	17 960	8 607	15 357	11 478	12 576	4 544	5 484	6 784
	PKTM III	560 × 560	17 987	8 634	15 384	11 504	12 603	4 571	5 511	6 811
	PKTM III	560 × 600	18 087	8 734	15 485	11 605	12 704	4 671	5 611	6 911
	PKTM III	560 × 630	18 164	8 811	15 562	11 682	12 780	4 748	5 688	6 988
	PKTM III	560 × 650	18 217	8 864	15 614	11 734	12 833	4 800	5 740	7 040
	PKTM III	560 × 710	18 366	9 013	15 763	11 883	12 982	4 950	5 890	7 190
	PKTM III	560 × 750	18 469	9 116	15 866	11 986	13 085	5 053	5 993	7 293
	PKTM III	560 × 800	18 593	9 240	15 990	12 111	13 209	5 177	6 117	7 417
	PKTM 90	560 × 900	19 432	10 622	16 829	13 797	15 233	6 016	6 956	8 256
	PKTM 90	560 × 1 000	19 854	11 045	17 252	14 219	15 656	6 438	7 378	8 678
	PKTM III	600 × 160	16 761	7 408	14 158	10 279	11 377	3 345	4 285	5 585
	PKTM III	600 × 180	16 811	7 458	14 209	10 329	11 428	3 395	4 335	5 635
	PKTM III	600 × 200	16 865	7 512	14 262	10 382	11 481	3 449	4 389	5 689
	PKTM III	600 × 250	17 032	7 679	14 429	10 549	11 648	3 616	4 556	5 856
	PKTM III	600 × 280	17 112	7 759	14 509	10 629	11 728	3 696	4 636	5 936
	PKTM III	600 × 300	17 165	7 812	14 562	10 682	11 781	3 749	4 689	5 989
	PKTM III	600 × 315	17 205	7 852	14 602	10 722	11 821	3 789	4 729	6 029
	PKTM III	600 × 355	17 390	8 037	14 788	10 908	12 006	3 974	4 914	6 214
	PKTM III	600 × 400	17 590	8 238	14 988	11 108	12 207	4 174	5 114	6 414
	PKTM III	600 × 450	17 800	8 447	15 198	11 318	12 416	4 384	5 324	6 624
	PKTM III	600 × 500	17 930	8 577	15 328	11 448	12 546	4 514	5 454	6 754
	PKTM III	600 × 550	18 061	8 708	15 458	11 579	12 677	4 645	5 585	6 885
	PKTM III	600 × 560	18 090	8 737	15 488	11 608	12 706	4 674	5 614	6 914
	PKTM III	600 × 600	18 197	8 844	15 594	11 714	12 813	4 781	5 721	7 021
	PKTM III	600 × 630	18 276	8 923	15 674	11 794	12 893	4 860	5 800	7 100
	PKTM III	600 × 650	18 332	8 979	15 729	11 849	12 948	4 916	5 856	7 156
	PKTM III	600 × 710	18 489	9 136	15 887	12 007	13 105	5 073	6 013	7 313
	PKTM III	600 × 750	18 595	9 242	15 992	12 113	13 211	5 179	6 119	7 419
	PKTM III	600 × 800	18 728	9 375	16 125	12 245	13 344	5 312	6 252	7 552
	PKTM 90	600 × 900	19 729	10 919	17 126	14 094	15 530	6 313	7 253	8 553
	PKTM 90	600 × 1 000	20 024	11 214	17 421	14 389	15 825	6 608	7 548	8 848

Požární klapky									
Klapka	Rozměr (mm)	Provedení a cena v Kč							
		.01	.11	.20	.21/22	.23	.24/25	.40	
PKTM III	630 × 160	2 531	2 801	3 861	5 131	4 091	5 351	8 071	
PKTM III	630 × 180	2 584	2 854	3 914	5 184	4 144	5 404	8 125	
PKTM III	630 × 200	2 637	2 907	3 967	5 237	4 197	5 457	8 178	
PKTM III	630 × 250	2 810	3 080	4 140	5 410	4 370	5 630	8 351	
PKTM III	630 × 280	2 892	3 162	4 222	5 492	4 452	5 712	8 433	
PKTM III	630 × 300	2 948	3 218	4 278	5 548	4 508	5 768	8 489	
PKTM III	630 × 315	2 988	3 258	4 318	5 588	4 548	5 808	8 529	
PKTM III	630 × 355	3 180	3 450	4 510	5 780	4 740	6 000	8 720	
PKTM III	630 × 400	3 460	3 730	4 790	6 060	5 020	6 280	9 001	
PKTM III	630 × 450	3 598	3 868	4 928	6 198	5 158	6 418	9 139	
PKTM III	630 × 500	3 734	4 004	5 064	6 334	5 294	6 554	9 274	
PKTM III	630 × 550	3 870	4 140	5 200	6 470	5 430	6 690	9 411	
PKTM III	630 × 560	3 897	4 167	5 227	6 497	5 457	6 717	9 437	
PKTM III	630 × 600	4 009	4 279	5 339	6 609	5 569	6 829	9 550	
PKTM III	630 × 630	4 036	4 306	5 366	6 636	5 596	6 856	9 576	
PKTM III	630 × 650	4 149	4 419	5 479	6 749	5 709	6 969	9 690	
PKTM III	630 × 710	4 312	4 582	5 642	6 912	5 872	7 132	9 853	
PKTM III	630 × 750	4 424	4 694	5 754	7 024	5 984	7 244	9 965	
PKTM 90	630 × 800	5 013	5 283	6 343	7 613	6 573	7 833	11 341	
PKTM 90	630 × 900	5 575	5 845	6 905	8 175	7 135	8 395	11 903	
PKTM 90	630 × 1 000	5 880	6 150	7 210	8 480	7 440	8 700	12 208	
PKTM III	650 × 160	2 553	2 823	3 883	5 153	4 113	5 373	8 093	
PKTM III	650 × 180	2 609	2 879	3 939	5 209	4 169	5 429	8 149	
PKTM III	650 × 200	2 665	2 935	3 995	5 265	4 225	5 485	8 206	
PKTM III	650 × 250	2 840	3 110	4 170	5 440	4 400	5 660	8 381	
PKTM III	650 × 280	2 923	3 193	4 253	5 523	4 483	5 743	8 464	
PKTM III	650 × 300	2 982	3 252	4 312	5 582	4 542	5 802	8 522	
PKTM III	650 × 315	3 024	3 294	4 354	5 624	4 584	5 844	8 565	
PKTM III	650 × 355	3 371	3 641	4 701	5 971	4 931	6 191	8 912	
PKTM III	650 × 400	3 499	3 769	4 829	6 099	5 059	6 319	9 040	
PKTM III	650 × 450	3 640	3 910	4 970	6 240	5 200	6 460	9 181	
PKTM III	650 × 500	3 781	4 051	5 111	6 381	5 341	6 601	9 322	
PKTM III	650 × 550	3 917	4 187	5 247	6 517	5 477	6 737	9 458	
PKTM III	650 × 560	3 955	4 225	5 285	6 555	5 515	6 775	9 496	
PKTM III	650 × 600	4 062	4 332	5 392	6 662	5 622	6 882	9 603	
PKTM III	650 × 630	4 147	4 417	5 477	6 747	5 707	6 967	9 688	
PKTM III	650 × 650	4 205	4 475	5 535	6 805	5 765	7 025	9 746	
PKTM III	650 × 710	4 371	4 641	5 701	6 971	5 931	7 191	9 912	
PKTM III	650 × 750	4 485	4 755	5 815	7 085	6 045	7 305	10 026	
PKTM 90	650 × 800	5 401	5 671	6 731	8 001	6 961	8 221	11 729	
PKTM 90	650 × 900	5 884	6 154	7 214	8 484	7 444	8 704	12 212	
PKTM 90	650 × 1 000	6 215	6 485	7 545	8 815	7 775	9 035	12 543	

	Klapka	Rozměr (mm)	Provedení a cena v Kč							
			.41/.61	.50	.51	.60	.62	.80	.82	.83/.84
	PKTM III	630 × 160	16 797	7 444	14 194	10 314	11 413	3 381	4 321	5 621
	PKTM III	630 × 180	16 850	7 497	14 247	10 367	11 466	3 434	4 374	5 674
	PKTM III	630 × 200	16 903	7 550	14 301	10 421	11 520	3 487	4 427	5 727
	PKTM III	630 × 250	17 076	7 723	14 473	10 594	11 692	3 660	4 600	5 900
	PKTM III	630 × 280	17 158	7 806	14 556	10 676	11 775	3 742	4 682	5 982
	PKTM III	630 × 300	17 214	7 861	14 612	10 732	11 831	3 798	4 738	6 038
	PKTM III	630 × 315	17 254	7 901	14 652	10 772	11 870	3 838	4 778	6 078
	PKTM III	630 × 355	17 446	8 093	14 843	10 963	12 062	4 030	4 970	6 270
	PKTM III	630 × 400	17 726	8 373	15 123	11 244	12 342	4 310	5 250	6 550
	PKTM III	630 × 450	17 864	8 511	15 262	11 382	12 480	4 448	5 388	6 688
	PKTM III	630 × 500	18 000	8 647	15 397	11 517	12 616	4 584	5 524	6 824
	PKTM III	630 × 550	18 136	8 783	15 534	11 654	12 752	4 720	5 660	6 960
	PKTM III	630 × 560	18 163	8 810	15 560	11 680	12 779	4 747	5 687	6 987
	PKTM III	630 × 600	18 275	8 922	15 672	11 792	12 891	4 859	5 799	7 099
	PKTM III	630 × 630	18 302	8 949	15 699	11 819	12 918	4 886	5 826	7 126
	PKTM III	630 × 650	18 415	9 062	15 813	11 933	13 031	4 999	5 939	7 239
	PKTM III	630 × 710	18 578	9 226	15 976	12 096	13 195	5 162	6 102	7 402
	PKTM III	630 × 750	18 690	9 337	16 087	12 208	13 306	5 274	6 214	7 514
	PKTM 90	630 × 800	19 279	10 469	16 676	13 644	15 081	5 863	6 803	8 103
	PKTM 90	630 × 900	19 841	11 031	17 238	14 206	15 642	6 425	7 365	8 665
	PKTM 90	630 × 1 000	20 146	11 336	17 543	14 511	15 948	6 730	7 670	8 970
	PKTM III	650 × 160	16 819	7 466	14 216	10 336	11 435	3 403	4 343	5 643
	PKTM III	650 × 180	16 875	7 522	14 272	10 392	11 491	3 459	4 399	5 699
	PKTM III	650 × 200	16 931	7 578	14 328	10 449	11 547	3 515	4 455	5 755
	PKTM III	650 × 250	17 106	7 753	14 504	10 624	11 723	3 690	4 630	5 930
	PKTM III	650 × 280	17 189	7 836	14 586	10 707	11 805	3 773	4 713	6 013
	PKTM III	650 × 300	17 248	7 895	14 645	10 765	11 864	3 832	4 772	6 072
	PKTM III	650 × 315	17 290	7 938	14 688	10 808	11 907	3 874	4 814	6 114
	PKTM III	650 × 355	17 638	8 285	15 035	11 155	12 254	4 221	5 161	6 461
	PKTM III	650 × 400	17 765	8 412	15 162	11 283	12 381	4 349	5 289	6 589
	PKTM III	650 × 450	17 906	8 553	15 303	11 424	12 522	4 490	5 430	6 730
	PKTM III	650 × 500	18 047	8 694	15 444	11 565	12 663	4 631	5 571	6 871
	PKTM III	650 × 550	18 183	8 831	15 581	11 701	12 800	4 767	5 707	7 007
	PKTM III	650 × 560	18 221	8 868	15 619	11 739	12 837	4 805	5 745	7 045
	PKTM III	650 × 600	18 328	8 975	15 725	11 845	12 944	4 912	5 852	7 152
	PKTM III	650 × 630	18 413	9 060	15 810	11 931	13 029	4 997	5 937	7 237
	PKTM III	650 × 650	18 471	9 118	15 868	11 989	13 087	5 055	5 995	7 295
	PKTM III	650 × 710	18 637	9 284	16 035	12 155	13 253	5 221	6 161	7 461
	PKTM III	650 × 750	18 751	9 398	16 149	12 269	13 367	5 335	6 275	7 575
	PKTM 90	650 × 800	19 667	10 857	17 064	14 032	15 468	6 251	7 191	8 491
	PKTM 90	650 × 900	20 150	11 340	17 547	14 515	15 951	6 734	7 674	8 974
	PKTM 90	650 × 1000	20 481	11 671	17 878	14 846	16 283	7 065	8 005	9 305

Požární klapky									
Klapka	Rozměr (mm)	Provedení a cena v Kč							
		.01	.11	.20	.21/22	.23	.24/25	.40	
PKTM III	710×160	2 626	2 896	3 956	5 226	4 186	5 446	8 167	
PKTM III	710×180	2 687	2 957	4 017	5 287	4 247	5 507	8 228	
PKTM III	710×200	2 747	3 017	4 077	5 347	4 307	5 567	8 287	
PKTM III	710×250	2 930	3 200	4 260	5 530	4 490	5 750	8 471	
PKTM III	710×280	3 021	3 291	4 351	5 621	4 581	5 841	8 562	
PKTM III	710×300	3 216	3 486	4 546	5 816	4 776	6 036	8 757	
PKTM III	710×315	3 259	3 529	4 589	5 859	4 819	6 079	8 799	
PKTM III	710×355	3 484	3 754	4 814	6 084	5 044	6 304	9 025	
PKTM III	710×400	3 620	3 890	4 950	6 220	5 180	6 440	9 161	
PKTM III	710×450	3 769	4 039	5 099	6 369	5 329	6 589	9 310	
PKTM III	710×500	3 919	4 189	5 249	6 519	5 479	6 739	9 460	
PKTM III	710×550	4 067	4 337	5 397	6 667	5 627	6 887	9 607	
PKTM III	710×560	4 069	4 339	5 399	6 669	5 629	6 889	9 610	
PKTM III	710×600	4 219	4 489	5 549	6 819	5 779	7 039	9 760	
PKTM III	710×630	4 310	4 580	5 640	6 910	5 870	7 130	9 851	
PKTM III	710×650	4 371	4 641	5 701	6 971	5 931	7 191	9 912	
PKTM 90	710×710	4 990	5 260	6 320	7 590	6 550	7 810	11 318	
PKTM 90	710×750	5 119	5 389	6 449	7 719	6 679	7 939	11 447	
PKTM 90	710×800	5 401	5 671	6 731	8 001	6 961	8 221	11 729	
PKTM 90	710×900	5 884	6 154	7 214	8 484	7 444	8 704	12 212	
PKTM 90	710×1 000	6 215	6 485	7 545	8 815	7 775	9 035	12 543	
PKTM III	750×160	2 677	2 947	4 007	5 277	4 237	5 497	8 218	
PKTM III	750×180	2 739	3 009	4 069	5 339	4 299	5 559	8 280	
PKTM III	750×200	2 801	3 071	4 131	5 401	4 361	5 621	8 342	
PKTM III	750×250	3 046	3 316	4 376	5 646	4 606	5 866	8 587	
PKTM III	750×280	3 220	3 490	4 550	5 820	4 780	6 040	8 761	
PKTM III	750×300	3 284	3 554	4 614	5 884	4 844	6 104	8 825	
PKTM III	750×315	3 330	3 600	4 660	5 930	4 890	6 150	8 871	
PKTM III	750×355	3 558	3 828	4 888	6 158	5 118	6 378	9 099	
PKTM III	750×400	3 700	3 970	5 030	6 300	5 260	6 520	9 240	
PKTM III	750×450	3 858	4 128	5 188	6 458	5 418	6 678	9 398	
PKTM III	750×500	4 013	4 283	5 343	6 613	5 573	6 833	9 554	
PKTM III	750×550	4 166	4 436	5 496	6 766	5 726	6 986	9 707	
PKTM III	750×560	4 201	4 471	5 531	6 801	5 761	7 021	9 742	
PKTM III	750×600	4 327	4 597	5 657	6 927	5 887	7 147	9 868	
PKTM III	750×630	4 421	4 691	5 751	7 021	5 981	7 241	9 962	
PKTM III	750×650	4 485	4 755	5 815	7 085	6 045	7 305	10 025	
PKTM 90	750×710	5 119	5 389	6 449	7 719	6 679	7 939	11 446	
PKTM 90	750×750	5 253	5 523	6 583	7 853	6 813	8 073	11 580	
PKTM 90	750×800	5 541	5 811	6 871	8 141	7 101	8 361	11 869	
PKTM 90	750×900	6 037	6 307	7 367	8 637	7 597	8 857	12 365	
PKTM 90	750×1 000	6 382	6 652	7 712	8 982	7 942	9 202	12 710	

	Klapka	Rozměr (mm)	Provedení a cena v Kč							
			.41/.61	.50	.51	.60	.62	.80	.82	.83/.84
	PKTM III	710 × 160	16 892	7 539	14 289	10 409	11 508	3 476	4 416	5 716
	PKTM III	710 × 180	16 953	7 601	14 351	10 471	11 570	3 537	4 477	5 777
	PKTM III	710 × 200	17 013	7 660	14 410	10 530	11 629	3 597	4 537	5 837
	PKTM III	710 × 250	17 196	7 844	14 594	10 714	11 813	3 780	4 720	6 020
	PKTM III	710 × 280	17 288	7 935	14 685	10 805	11 904	3 871	4 811	6 111
	PKTM III	710 × 300	17 482	8 129	14 879	10 999	12 098	4 066	5 006	6 306
	PKTM III	710 × 315	17 525	8 172	14 922	11 042	12 141	4 109	5 049	6 349
	PKTM III	710 × 355	17 750	8 397	15 148	11 268	12 366	4 334	5 274	6 574
	PKTM III	710 × 400	17 886	8 533	15 283	11 404	12 502	4 470	5 410	6 710
	PKTM III	710 × 450	18 035	8 682	15 433	11 553	12 652	4 619	5 559	6 859
	PKTM III	710 × 500	18 185	8 832	15 582	11 703	12 801	4 769	5 709	7 009
	PKTM III	710 × 550	18 333	8 980	15 730	11 850	12 949	4 917	5 857	7 157
	PKTM III	710 × 560	18 335	8 982	15 732	11 853	12 951	4 919	5 859	7 159
	PKTM III	710 × 600	18 485	9 133	15 883	12 003	13 102	5 069	6 009	7 309
	PKTM III	710 × 630	18 576	9 223	15 974	12 094	13 192	5 160	6 100	7 400
	PKTM III	710 × 650	18 637	9 284	16 035	12 155	13 253	5 221	6 161	7 461
	PKTM 90	710 × 710	19 256	10 446	16 654	13 621	15 058	5 840	6 780	8 080
	PKTM 90	710 × 750	19 385	10 575	16 782	13 750	15 186	5 969	6 909	8 209
	PKTM 90	710 × 800	19 667	10 857	17 064	14 032	15 468	6 251	7 191	8 491
	PKTM 90	710 × 900	20 150	11 340	17 547	14 515	15 951	6 734	7 674	8 974
	PKTM 90	710 × 1 000	20 481	11 671	17 878	14 846	16 283	7 065	8 005	9 305
	PKTM III	750 × 160	16 943	7 590	14 341	10 461	11 559	3 527	4 467	5 767
	PKTM III	750 × 180	17 005	7 652	14 402	10 523	11 621	3 589	4 529	5 829
	PKTM III	750 × 200	17 067	7 714	14 464	10 585	11 683	3 651	4 591	5 891
	PKTM III	750 × 250	17 312	7 959	14 709	10 830	11 928	3 896	4 836	6 136
	PKTM III	750 × 280	17 486	8 133	14 883	11 004	12 102	4 070	5 010	6 310
	PKTM III	750 × 300	17 550	8 197	14 948	11 068	12 166	4 134	5 074	6 374
	PKTM III	750 × 315	17 596	8 243	14 993	11 113	12 212	4 180	5 120	6 420
	PKTM III	750 × 355	17 824	8 471	15 222	11 342	12 440	4 408	5 348	6 648
	PKTM III	750 × 400	17 966	8 613	15 363	11 483	12 582	4 550	5 490	6 790
	PKTM III	750 × 450	18 124	8 771	15 521	11 641	12 740	4 708	5 648	6 948
	PKTM III	750 × 500	18 279	8 926	15 676	11 796	12 895	4 863	5 803	7 103
	PKTM III	750 × 550	18 432	9 079	15 830	11 950	13 048	5 016	5 956	7 256
	PKTM III	750 × 560	18 467	9 114	15 865	11 985	13 083	5 051	5 991	7 291
	PKTM III	750 × 600	18 593	9 240	15 991	12 111	13 209	5 177	6 117	7 417
	PKTM III	750 × 630	18 687	9 334	16 084	12 205	13 303	5 271	6 211	7 511
	PKTM III	750 × 650	18 751	9 398	16 148	12 268	13 367	5 335	6 275	7 575
	PKTM 90	750 × 710	19 385	10 575	16 782	13 750	15 186	5 969	6 909	8 209
	PKTM 90	750 × 750	19 519	10 709	16 916	13 884	15 320	6 103	7 043	8 343
	PKTM 90	750 × 800	19 807	10 998	17 205	14 172	15 609	6 391	7 331	8 631
	PKTM 90	750 × 900	20 303	11 494	17 701	14 668	16 105	6 887	7 827	9 127
	PKTM 90	750 × 1 000	20 648	11 838	18 045	15 013	16 449	7 232	8 172	9 472

Požární klapky									
Klapka	Rozměr (mm)	Provedení a cena v Kč							
		.01	.11	.20	.21/22	.23	.24/25	.40	
PKTM III	800 × 160	2 735	3 005	4 065	5 335	4 295	5 555	8 276	
PKTM III	800 × 180	2 803	3 073	4 133	5 403	4 363	5 623	8 344	
PKTM III	800 × 200	2 923	3 193	4 253	5 523	4 483	5 743	8 464	
PKTM III	800 × 250	3 198	3 468	4 528	5 798	4 758	6 018	8 739	
PKTM III	800 × 280	3 298	3 568	4 628	5 898	4 858	6 118	8 839	
PKTM III	800 × 300	3 365	3 635	4 695	5 965	4 925	6 185	8 906	
PKTM III	800 × 315	3 413	3 683	4 743	6 013	4 973	6 233	8 954	
PKTM III	800 × 355	3 650	3 920	4 980	6 250	5 210	6 470	9 191	
PKTM III	800 × 400	3 800	4 070	5 130	6 400	5 360	6 620	9 341	
PKTM III	800 × 450	3 964	4 234	5 294	6 564	5 524	6 784	9 504	
PKTM III	800 × 500	4 072	4 342	5 402	6 672	5 632	6 892	9 613	
PKTM III	800 × 550	4 292	4 562	5 622	6 892	5 852	7 112	9 833	
PKTM III	800 × 560	4 324	4 594	5 654	6 924	5 884	7 144	9 865	
PKTM III	800 × 600	4 459	4 729	5 789	7 059	6 019	7 279	10 000	
PKTM 90	800 × 630	4 988	5 258	6 318	7 588	6 548	7 808	11 316	
PKTM 90	800 × 650	5 065	5 335	6 395	7 665	6 625	7 885	11 393	
PKTM 90	800 × 710	5 289	5 559	6 619	7 889	6 849	8 109	11 616	
PKTM 90	800 × 750	5 429	5 699	6 759	8 029	6 989	8 249	11 757	
PKTM 90	800 × 800	5 726	5 996	7 056	8 326	7 286	8 546	12 054	
PKTM 90	800 × 900	6 238	6 508	7 568	8 838	7 798	9 058	12 566	
PKTM 90	800 × 1 000	6 599	6 869	7 929	9 199	8 159	9 419	12 927	
PKTM III	900 × 160	2 996	3 266	4 326	5 596	4 556	5 816	8 537	
PKTM III	900 × 180	3 066	3 336	4 396	5 666	4 626	5 886	8 607	
PKTM III	900 × 200	3 140	3 410	4 470	5 740	4 700	5 960	8 680	
PKTM III	900 × 250	3 354	3 624	4 684	5 954	4 914	6 174	8 895	
PKTM III	900 × 280	3 462	3 732	4 792	6 062	5 022	6 282	9 003	
PKTM III	900 × 300	3 538	3 808	4 868	6 138	5 098	6 358	9 079	
PKTM III	900 × 315	3 592	3 862	4 922	6 192	5 152	6 412	9 133	
PKTM III	900 × 355	3 840	4 110	5 170	6 440	5 400	6 660	9 381	
PKTM III	900 × 400	4 004	4 274	5 334	6 604	5 564	6 824	9 545	
PKTM III	900 × 450	4 184	4 454	5 514	6 784	5 744	7 004	9 725	
PKTM III	900 × 500	4 365	4 635	5 695	6 965	5 925	7 185	9 906	
PKTM III	900 × 550	4 544	4 814	5 874	7 144	6 104	7 364	10 085	
PKTM 90	900 × 560	5 113	5 383	6 443	7 713	6 673	7 933	11 441	
PKTM 90	900 × 600	5 393	5 663	6 723	7 993	6 953	8 213	11 721	
PKTM 90	900 × 630	5 476	5 746	6 806	8 076	7 036	8 296	11 804	
PKTM 90	900 × 710	5 720	5 990	7 050	8 320	7 280	8 540	12 048	
PKTM 90	900 × 750	5 873	6 143	7 203	8 473	7 433	8 693	12 201	
PKTM 90	900 × 800	6 081	6 351	7 411	8 681	7 641	8 901	12 409	
PKTM 90	900 × 900	6 627	6 897	7 957	9 227	8 187	9 447	12 954	
PKTM 90	900 × 1 000	7 020	7 290	8 350	9 620	8 580	9 840	13 348	
PKTM III	1 000 × 160	3 122	3 392	4 452	5 722	4 682	5 942	8 663	

	Klapka	Rozměr (mm)	Provedení a cena v Kč							
			.41/.61	.50	.51	.60	.62	.80	.82	.83/.84
	PKTM III	800 × 160	17 001	7 648	14 399	10 519	11 618	3 585	4 525	5 825
	PKTM III	800 × 180	17 069	7 716	14 466	10 586	11 685	3 653	4 593	5 893
	PKTM III	800 × 200	17 189	7 836	14 587	10 707	11 805	3 773	4 713	6 013
	PKTM III	800 × 250	17 464	8 111	14 862	10 982	12 080	4 048	4 988	6 288
	PKTM III	800 × 280	17 564	8 211	14 961	11 081	12 180	4 148	5 088	6 388
	PKTM III	800 × 300	17 631	8 278	15 028	11 149	12 247	4 215	5 155	6 455
	PKTM III	800 × 315	17 679	8 326	15 077	11 197	12 296	4 263	5 203	6 503
	PKTM III	800 × 355	17 916	8 563	15 314	11 434	12 532	4 500	5 440	6 740
	PKTM III	800 × 400	18 066	8 713	15 463	11 584	12 682	4 650	5 590	6 890
	PKTM III	800 × 450	18 230	8 877	15 627	11 747	12 846	4 814	5 754	7 054
	PKTM III	800 × 500	18 338	8 985	15 735	11 855	12 954	4 922	5 862	7 162
	PKTM III	800 × 550	18 558	9 205	15 955	12 076	13 174	5 142	6 082	7 382
	PKTM III	800 × 560	18 590	9 237	15 988	12 108	13 206	5 174	6 114	7 414
	PKTM III	800 × 600	18 725	9 372	16 122	12 242	13 341	5 309	6 249	7 549
	PKTM 90	800 × 630	19 254	10 444	16 652	13 619	15 056	5 838	6 778	8 078
	PKTM 90	800 × 650	19 331	10 521	16 728	13 696	15 133	5 915	6 855	8 155
	PKTM 90	800 × 710	19 555	10 745	16 952	13 920	15 356	6 139	7 079	8 379
	PKTM 90	800 × 750	19 695	10 885	17 093	14 060	15 497	6 279	7 219	8 519
	PKTM 90	800 × 800	19 992	11 182	17 390	14 357	15 794	6 576	7 516	8 816
	PKTM 90	800 × 900	20 504	11 695	17 902	14 870	16 306	7 088	8 028	9 328
	PKTM 90	800 × 1 000	20 865	12 056	18 263	15 230	16 667	7 449	8 389	9 689
	PKTM III	900 × 160	17 262	7 909	14 659	10 780	11 878	3 846	4 786	6 086
	PKTM III	900 × 180	17 332	7 979	14 730	10 850	11 948	3 916	4 856	6 156
	PKTM III	900 × 200	17 406	8 053	14 803	10 923	12 022	3 990	4 930	6 230
	PKTM III	900 × 250	17 620	8 267	15 018	11 138	12 236	4 204	5 144	6 444
	PKTM III	900 × 280	17 728	8 375	15 126	11 246	12 344	4 312	5 252	6 552
	PKTM III	900 × 300	17 804	8 451	15 201	11 322	12 420	4 388	5 328	6 628
	PKTM III	900 × 315	17 858	8 505	15 255	11 376	12 474	4 442	5 382	6 682
	PKTM III	900 × 355	18 106	8 753	15 503	11 624	12 722	4 690	5 630	6 930
	PKTM III	900 × 400	18 270	8 917	15 667	11 788	12 886	4 854	5 794	7 094
	PKTM III	900 × 450	18 450	9 098	15 848	11 968	13 067	5 034	5 974	7 274
	PKTM III	900 × 500	18 631	9 278	16 028	12 149	13 247	5 215	6 155	7 455
	PKTM III	900 × 550	18 810	9 457	16 207	12 327	13 426	5 394	6 334	7 634
	PKTM 90	900 × 560	19 379	10 570	16 777	13 745	15 181	5 963	6 903	8 203
	PKTM 90	900 × 600	19 659	10 849	17 056	14 024	15 461	6 243	7 183	8 483
	PKTM 90	900 × 630	19 742	10 933	17 140	14 107	15 544	6 326	7 266	8 566
	PKTM 90	900 × 710	19 986	11 176	17 383	14 351	15 787	6 570	7 510	8 810
	PKTM 90	900 × 750	20 139	11 330	17 537	14 504	15 941	6 723	7 663	8 963
	PKTM 90	900 × 800	20 347	11 538	17 745	14 712	16 149	6 931	7 871	9 171
	PKTM 90	900 × 900	20 893	12 083	18 290	15 258	16 694	7 477	8 417	9 717
	PKTM 90	900 × 1 000	21 286	12 476	18 684	15 651	17 088	7 870	8 810	10 110
	PKTM III	1 000 × 160	17 388	8 036	14 786	10 906	12 005	3 972	4 912	6 212

Požární klapky									
Klapka	Rozměr (mm)	Provedení a cena v Kč							
		.01	.11	.20	.21/22	.23	.24/25	.40	
PKTM III	1 000 × 180	3 201	3 471	4 531	5 801	4 761	6 021	8 742	
PKTM III	1 000 × 200	3 280	3 550	4 610	5 880	4 840	6 100	8 821	
PKTM III	1 000 × 250	3 512	3 782	4 842	6 112	5 072	6 332	9 053	
PKTM III	1 000 × 280	3 628	3 898	4 958	6 228	5 188	6 448	9 169	
PKTM III	1 000 × 300	3 709	3 979	5 039	6 309	5 269	6 529	9 250	
PKTM III	1 000 × 315	3 769	4 039	5 099	6 369	5 329	6 589	9 310	
PKTM III	1 000 × 355	4 031	4 301	5 361	6 631	5 591	6 851	9 572	
PKTM III	1 000 × 400	4 209	4 479	5 539	6 809	5 769	7 029	9 750	
PKTM III	1 000 × 450	4 404	4 674	5 734	7 004	5 964	7 224	9 945	
PKTM III	1 000 × 500	4 601	4 871	5 931	7 201	6 161	7 421	10 142	
PKTM 90	1 000 × 550	5 344	5 614	6 674	7 944	6 904	8 164	11 672	
PKTM 90	1 000 × 560	5 387	5 657	6 717	7 987	6 947	8 207	11 715	
PKTM 90	1 000 × 600	5 689	5 959	7 019	8 289	7 249	8 509	12 017	
PKTM 90	1 000 × 630	5 689	5 959	7 019	8 289	7 249	8 509	12 017	
PKTM 90	1 000 × 650	5 779	6 049	7 109	8 379	7 339	8 599	12 107	
PKTM 90	1 000 × 710	6 042	6 312	7 372	8 642	7 602	8 862	12 370	
PKTM 90	1 000 × 750	6 209	6 479	7 539	8 809	7 769	9 029	12 537	
PKTM 90	1 000 × 800	6 574	6 844	7 904	9 174	8 134	9 394	12 902	
PKTM 90	1 000 × 900	7 011	7 281	8 341	9 611	8 571	9 831	13 339	
PKTM 90	1 000 × 1 000	7 438	7 708	8 768	10 038	8 998	10 258	13 766	
PKTM 90	1 100 × 180	4 815	5 085	6 145	7 415	6 375	7 635	11 143	
PKTM 90	1 100 × 200	4 815	5 085	6 145	7 415	6 375	7 635	11 143	
PKTM 90	1 100 × 250	4 815	5 085	6 145	7 415	6 375	7 635	11 143	
PKTM 90	1 100 × 280	4 815	5 085	6 145	7 415	6 375	7 635	11 143	
PKTM 90	1 100 × 300	4 815	5 085	6 145	7 415	6 375	7 635	11 143	
PKTM 90	1 100 × 315	4 815	5 085	6 145	7 415	6 375	7 635	11 143	
PKTM 90	1 100 × 400	4 815	5 085	6 145	7 415	6 375	7 635	11 143	
PKTM 90	1 100 × 450	5 049	5 319	6 379	7 649	6 609	7 869	11 377	
PKTM 90	1 100 × 500	5 387	5 657	6 717	7 987	6 947	8 207	11 714	
PKTM 90	1 100 × 550	5 618	5 888	6 948	8 218	7 178	8 438	11 946	
PKTM 90	1 100 × 560	5 664	5 934	6 994	8 264	7 224	8 484	11 992	
PKTM 90	1 100 × 600	5 990	6 260	7 320	8 590	7 550	8 810	12 318	
PKTM 90	1 100 × 630	5 990	6 260	7 320	8 590	7 550	8 810	12 318	
PKTM 90	1 100 × 650	6 086	6 356	7 416	8 686	7 646	8 906	12 414	
PKTM 90	1 100 × 710	6 369	6 639	7 699	8 969	7 929	9 189	12 697	
PKTM 90	1 100 × 750	6 549	6 819	7 879	9 149	8 109	9 369	12 877	
PKTM 90	1 100 × 800	6 930	7 200	8 260	9 530	8 490	9 750	13 258	
PKTM 90	1 100 × 900	7 400	7 670	8 730	10 000	8 960	10 220	13 728	
PKTM 90	1 100 × 1 000	7 860	8 130	9 190	10 460	9 420	10 680	14 187	
PKTM 90	1 250 × 180	5 773	6 043	7 103	8 373	7 333	8 593	12 101	
PKTM 90	1 250 × 200	5 773	6 043	7 103	8 373	7 333	8 593	12 101	
PKTM 90	1 250 × 250	5 773	6 043	7 103	8 373	7 333	8 593	12 101	

	Klapka	Rozměr (mm)	Provedení a cena v Kč							
			.41/.61	.50	.51	.60	.62	.80	.82	.83/.84
	PKTM III	1 000×180	17 467	8 114	14 865	10 985	12 083	4 051	4 991	6 291
	PKTM III	1 000×200	17 546	8 193	14 943	11 064	12 162	4 130	5 070	6 370
	PKTM III	1 000×250	17 778	8 425	15 175	11 295	12 394	4 362	5 302	6 602
	PKTM III	1 000×280	17 894	8 541	15 292	11 412	12 510	4 478	5 418	6 718
	PKTM III	1 000×300	17 975	8 622	15 373	11 493	12 591	4 559	5 499	6 799
	PKTM III	1 000×315	18 035	8 682	15 432	11 553	12 651	4 619	5 559	6 859
	PKTM III	1 000×355	18 297	8 944	15 695	11 815	12 913	4 881	5 821	7 121
	PKTM III	1 000×400	18 475	9 122	15 873	11 993	13 091	5 059	5 999	7 299
	PKTM III	1 000×450	18 670	9 317	16 067	12 187	13 286	5 254	6 194	7 494
	PKTM III	1 000×500	18 867	9 514	16 265	12 385	13 484	5 451	6 391	7 691
	PKTM 90	1 000×550	19 610	10 800	17 007	13 975	15 411	6 194	7 134	8 434
	PKTM 90	1 000×560	19 653	10 843	17 050	14 018	15 454	6 237	7 177	8 477
	PKTM 90	1 000×600	19 955	11 146	17 353	14 320	15 757	6 539	7 479	8 779
	PKTM 90	1 000×630	19 955	11 146	17 353	14 320	15 757	6 539	7 479	8 779
	PKTM 90	1 000×650	20 045	11 235	17 443	14 410	15 847	6 629	7 569	8 869
	PKTM 90	1 000×710	20 308	11 498	17 706	14 673	16 110	6 892	7 832	9 132
	PKTM 90	1 000×750	20 475	11 665	17 872	14 840	16 277	7 059	7 999	9 299
	PKTM 90	1 000×800	20 840	12 030	18 237	15 205	16 642	7 424	8 364	9 664
	PKTM 90	1 000×900	21 277	12 468	18 675	15 642	17 079	7 861	8 801	10 101
	PKTM 90	1 000×1 000	21 704	12 894	19 101	16 069	17 505	8 288	9 228	10 528
	PKTM 90	1 100×180	19 081	10 271	16 478	13 446	14 882	5 665	6 605	7 905
	PKTM 90	1 100×200	19 081	10 271	16 478	13 446	14 882	5 665	6 605	7 905
	PKTM 90	1 100×250	19 081	10 271	16 478	13 446	14 882	5 665	6 605	7 905
	PKTM 90	1 100×280	19 081	10 271	16 478	13 446	14 882	5 665	6 605	7 905
	PKTM 90	1 100×300	19 081	10 271	16 478	13 446	14 882	5 665	6 605	7 905
	PKTM 90	1 100×315	19 081	10 271	16 478	13 446	14 882	5 665	6 605	7 905
	PKTM 90	1 100×400	19 081	10 271	16 478	13 446	14 882	5 665	6 605	7 905
	PKTM 90	1 100×450	19 315	10 505	16 713	13 680	15 117	5 899	6 839	8 139
	PKTM 90	1 100×500	19 653	10 843	17 050	14 018	15 454	6 237	7 177	8 477
	PKTM 90	1 100×550	19 884	11 074	17 282	14 249	15 686	6 468	7 408	8 708
	PKTM 90	1 100×560	19 930	11 121	17 328	14 295	15 732	6 514	7 454	8 754
	PKTM 90	1 100×600	20 256	11 446	17 653	14 621	16 057	6 840	7 780	9 080
	PKTM 90	1 100×630	20 256	11 446	17 653	14 621	16 057	6 840	7 780	9 080
	PKTM 90	1 100×650	20 352	11 543	17 750	14 717	16 154	6 936	7 876	9 176
	PKTM 90	1 100×710	20 635	11 825	18 032	15 000	16 437	7 219	8 159	9 459
	PKTM 90	1 100×750	20 815	12 005	18 212	15 180	16 617	7 399	8 339	9 639
	PKTM 90	1 100×800	21 196	12 387	18 594	15 561	16 998	7 780	8 720	10 020
	PKTM 90	1 100×900	21 667	12 857	19 064	16 032	17 468	8 250	9 190	10 490
	PKTM 90	1 100×1 000	22 126	13 316	19 523	16 491	17 927	8 710	9 650	10 950
	PKTM 90	1 250×180	20 039	11 229	17 437	14 404	15 841	6 623	7 563	8 863
	PKTM 90	1 250×200	20 039	11 229	17 437	14 404	15 841	6 623	7 563	8 863
	PKTM 90	1 250×250	20 039	11 229	17 437	14 404	15 841	6 623	7 563	8 863

Požární klapky									
Klapka	Rozměr (mm)	Provedení a cena v Kč							
		.01	.11	.20	.21/22	.23	.24/25	.40	
PKTM 90	1 250 × 315	5 773	6 043	7 103	8 373	7 333	8 593	12 101	
PKTM 90	1 250 × 355	5 773	6 043	7 103	8 373	7 333	8 593	12 101	
PKTM 90	1 250 × 400	5 773	6 043	7 103	8 373	7 333	8 593	12 101	
PKTM 90	1 250 × 450	5 773	6 043	7 103	8 373	7 333	8 593	12 101	
PKTM 90	1 250 × 500	5 773	6 043	7 103	8 373	7 333	8 593	12 101	
PKTM 90	1 250 × 550	6 029	6 299	7 359	8 629	7 589	8 849	12 357	
PKTM 90	1 250 × 560	6 080	6 350	7 410	8 680	7 640	8 900	12 408	
PKTM 90	1 250 × 600	6 440	6 710	7 770	9 040	8 000	9 260	12 768	
PKTM 90	1 250 × 630	6 440	6 710	7 770	9 040	8 000	9 260	12 768	
PKTM 90	1 250 × 650	6 546	6 816	7 876	9 146	8 106	9 366	12 874	
PKTM 90	1 250 × 710	6 546	6 816	7 876	9 146	8 106	9 366	12 874	
PKTM 90	1 250 × 750	6 859	7 129	8 189	9 459	8 419	9 679	13 187	
PKTM 90	1 250 × 800	7 187	7 457	8 517	9 787	8 747	10 007	13 514	
PKTM 90	1 250 × 900	7 464	7 734	8 794	10 064	9 024	10 284	13 792	
PKTM 90	1 250 × 900	8 103	8 373	9 433	10 703	9 663	10 923	14 430	
PKTM 90	1 250 × 1 000	8 611	8 881	9 941	11 211	10 171	11 431	14 939	
PKTM 90	1 400 × 200	6 667	6 937	7 997	9 267	8 227	9 487	12 994	
PKTM 90	1 400 × 250	6 667	6 937	7 997	9 267	8 227	9 487	12 994	
PKTM 90	1 400 × 315	6 667	6 937	7 997	9 267	8 227	9 487	12 994	
PKTM 90	1 400 × 355	6 667	6 937	7 997	9 267	8 227	9 487	12 994	
PKTM 90	1 400 × 400	6 667	6 937	7 997	9 267	8 227	9 487	12 994	
PKTM 90	1 400 × 450	6 667	6 937	7 997	9 267	8 227	9 487	12 994	
PKTM 90	1 400 × 500	6 667	6 937	7 997	9 267	8 227	9 487	12 994	
PKTM 90	1 400 × 550	6 960	7 230	8 290	9 560	8 520	9 780	13 288	
PKTM 90	1 400 × 560	7 019	7 289	8 349	9 619	8 579	9 839	13 347	
PKTM 90	1 400 × 600	7 547	7 817	8 877	10 147	9 107	10 367	13 874	
PKTM 90	1 400 × 630	7 547	7 817	8 877	10 147	9 107	10 367	13 874	
PKTM 90	1 400 × 650	7 666	7 936	8 996	10 266	9 226	10 486	13 994	
PKTM 90	1 400 × 710	8 021	8 291	9 351	10 621	9 581	10 841	14 349	
PKTM 90	1 400 × 750	8 249	8 519	9 579	10 849	9 809	11 069	14 577	
PKTM 90	1 400 × 800	8 553	8 823	9 883	11 153	10 113	11 373	14 881	
PKTM 90	1 400 × 900	9 144	9 414	10 474	11 744	10 704	11 964	15 471	
PKTM 90	1 400 × 1 000	9 722	9 992	11 052	12 322	11 282	12 542	16 050	
PKTM 90	1 500 × 200	6 944	7 214	8 274	9 544	8 504	9 764	13 272	
PKTM 90	1 500 × 250	6 944	7 214	8 274	9 544	8 504	9 764	13 272	
PKTM 90	1 500 × 315	6 944	7 214	8 274	9 544	8 504	9 764	13 272	
PKTM 90	1 500 × 355	6 944	7 214	8 274	9 544	8 504	9 764	13 272	
PKTM 90	1 500 × 400	6 944	7 214	8 274	9 544	8 504	9 764	13 272	
PKTM 90	1 500 × 450	6 944	7 214	8 274	9 544	8 504	9 764	13 272	
PKTM 90	1 500 × 500	6 944	7 214	8 274	9 544	8 504	9 764	13 272	
PKTM 90	1 500 × 550	7 257	7 527	8 587	9 857	8 817	10 077	13 585	
PKTM 90	1 500 × 560	7 319	7 589	8 649	9 919	8 879	10 139	13 646	

	Klapka	Rozměr (mm)	Provedení a cena v Kč							
			.41/.61	.50	.51	.60	.62	.80	.82	.83/.84
	PKTM 90	1 250×315	20 039	11 229	17 437	14 404	15 841	6 623	7 563	8 863
	PKTM 90	1 250×355	20 039	11 229	17 437	14 404	15 841	6 623	7 563	8 863
	PKTM 90	1 250×400	20 039	11 229	17 437	14 404	15 841	6 623	7 563	8 863
	PKTM 90	1 250×450	20 039	11 229	17 437	14 404	15 841	6 623	7 563	8 863
	PKTM 90	1 250×500	20 039	11 229	17 437	14 404	15 841	6 623	7 563	8 863
	PKTM 90	1 250×550	20 295	11 485	17 693	14 660	16 097	6 879	7 819	9 119
	PKTM 90	1 250×560	20 346	11 537	17 744	14 711	16 148	6 930	7 870	9 170
	PKTM 90	1 250×600	20 706	11 896	18 104	15 071	16 508	7 290	8 230	9 530
	PKTM 90	1 250×630	20 706	11 896	18 104	15 071	16 508	7 290	8 230	9 530
	PKTM 90	1 250×650	20 812	12 003	18 210	15 178	16 614	7 396	8 336	9 636
	PKTM 90	1 250×710	20 812	12 003	18 210	15 178	16 614	7 396	8 336	9 636
	PKTM 90	1 250×750	21 125	12 315	18 522	15 490	16 926	7 709	8 649	9 949
	PKTM 90	1 250×800	21 453	12 643	18 850	15 818	17 254	8 037	8 977	10 277
	PKTM 90	1 250×900	21 730	12 921	19 128	16 095	17 532	8 314	9 254	10 554
	PKTM 90	1 250×900	22 369	13 559	19 766	16 734	18 170	8 953	9 893	11 193
	PKTM 90	1 250×1 000	22 877	14 067	20 274	17 242	18 678	9 461	10 401	11 701
	PKTM 90	1 400×200	20 933	12 123	18 330	15 298	16 734	7 517	8 457	9 757
	PKTM 90	1 400×250	20 933	12 123	18 330	15 298	16 734	7 517	8 457	9 757
	PKTM 90	1 400×315	20 933	12 123	18 330	15 298	16 734	7 517	8 457	9 757
	PKTM 90	1 400×355	20 933	12 123	18 330	15 298	16 734	7 517	8 457	9 757
	PKTM 90	1 400×400	20 933	12 123	18 330	15 298	16 734	7 517	8 457	9 757
	PKTM 90	1 400×450	20 933	12 123	18 330	15 298	16 734	7 517	8 457	9 757
	PKTM 90	1 400×500	20 933	12 123	18 330	15 298	16 734	7 517	8 457	9 757
	PKTM 90	1 400×550	21 226	12 417	18 624	15 591	17 028	7 810	8 750	10 050
	PKTM 90	1 400×560	21 285	12 475	18 682	15 650	17 086	7 869	8 809	10 109
	PKTM 90	1 400×600	21 813	13 003	19 210	16 178	17 614	8 397	9 337	10 637
	PKTM 90	1 400×630	21 813	13 003	19 210	16 178	17 614	8 397	9 337	10 637
	PKTM 90	1 400×650	21 932	13 122	19 329	16 297	17 733	8 516	9 456	10 756
	PKTM 90	1 400×710	22 287	13 478	19 685	16 652	18 089	8 871	9 811	11 111
	PKTM 90	1 400×750	22 515	13 705	19 912	16 880	18 317	9 099	10 039	11 339
	PKTM 90	1 400×800	22 819	14 010	20 217	17 184	18 621	9 403	10 343	11 643
	PKTM 90	1 400×900	23 410	14 600	20 807	17 775	19 211	9 994	10 934	12 234
	PKTM 90	1 400×1000	23 988	15 179	21 386	18 354	19 790	10 572	11 512	12 812
	PKTM 90	1 500×200	21 210	12 401	18 608	15 575	17 012	7 794	8 734	10 034
	PKTM 90	1 500×250	21 210	12 401	18 608	15 575	17 012	7 794	8 734	10 034
	PKTM 90	1 500×315	21 210	12 401	18 608	15 575	17 012	7 794	8 734	10 034
	PKTM 90	1 500×355	21 210	12 401	18 608	15 575	17 012	7 794	8 734	10 034
	PKTM 90	1 500×400	21 210	12 401	18 608	15 575	17 012	7 794	8 734	10 034
	PKTM 90	1 500×450	21 210	12 401	18 608	15 575	17 012	7 794	8 734	10 034
	PKTM 90	1 500×500	21 210	12 401	18 608	15 575	17 012	7 794	8 734	10 034
	PKTM 90	1 500×550	21 523	12 713	18 920	15 888	17 325	8 107	9 047	10 347
	PKTM 90	1 500×560	21 585	12 775	18 982	15 950	17 386	8 169	9 109	10 409

Požární klapky									
Klapka	Rozměr (mm)	Provedení a cena v Kč							
		.01	.11	.20	.21/22	.23	.24/25	.40	
PKTM 90	1 500×600	7 869	8 139	9 199	10 469	9 429	10 689	14 197	
PKTM 90	1 500×630	7 869	8 139	9 199	10 469	9 429	10 689	14 197	
PKTM 90	1 500×650	7 996	8 266	9 326	10 596	9 556	10 816	14 324	
PKTM 90	1 500×710	8 370	8 640	9 700	10 970	9 930	11 190	14 698	
PKTM 90	1 500×750	8 611	8 881	9 941	11 211	10 171	11 431	14 939	
PKTM 90	1 500×800	8 932	9 202	10 262	11 532	10 492	11 752	15 260	
PKTM 90	1 500×900	9 555	9 825	10 885	12 155	11 115	12 375	15 883	
PKTM 90	1 500×1 000	10 167	10 437	11 497	12 767	11 727	12 987	16 494	
PKTM 90	1 600×200	8 192	8 462	9 522	10 792	9 752	11 012	14 520	
PKTM 90	1 600×250	8 192	8 462	9 522	10 792	9 752	11 012	14 520	
PKTM 90	1 600×315	8 192	8 462	9 522	10 792	9 752	11 012	14 520	
PKTM 90	1 600×355	8 192	8 462	9 522	10 792	9 752	11 012	14 520	
PKTM 90	1 400×400	8 192	8 462	9 522	10 792	9 752	11 012	14 520	
PKTM 90	1 600×450	8 192	8 462	9 522	10 792	9 752	11 012	14 520	
PKTM 90	1 600×500	8 192	8 462	9 522	10 792	9 752	11 012	14 520	
PKTM 90	1 600×550	8 192	8 462	9 522	10 792	9 752	11 012	14 520	
PKTM 90	1 600×560	8 192	8 462	9 522	10 792	9 752	11 012	14 520	
PKTM 90	1 600×600	8 192	8 462	9 522	10 792	9 752	11 012	14 520	
PKTM 90	1 600×630	8 192	8 462	9 522	10 792	9 752	11 012	14 520	
PKTM 90	1 600×650	8 325	8 595	9 655	10 925	9 885	11 145	14 653	
PKTM 90	1 600×710	8 325	8 595	9 655	10 925	9 885	11 145	14 653	
PKTM 90	1 600×750	8 719	8 989	10 049	11 319	10 279	11 539	15 047	
PKTM 90	1 600×800	8 973	9 243	10 303	11 573	10 533	11 793	15 301	
PKTM 90	1 600×900	9 310	9 580	10 640	11 910	10 870	12 130	15 638	
PKTM 90	1 600×900	9 966	10 236	11 296	12 566	11 526	12 786	16 294	
PKTM 90	1 600×1 000	10 611	10 881	11 941	13 211	12 171	13 431	16 938	
PKTM III	ø 160	2 528	2 798	3 858	5 128	4 088	5 348	6 761	
PKTM III	ø 180	2 451	2 721	3 781	5 051	4 011	5 271	6 683	
PKTM III	ø 200	2 517	2 787	3 847	5 117	4 077	5 337	6 750	
PKTM III	ø 225	2 628	2 898	3 958	5 228	4 188	5 448	6 861	
PKTM III	ø 250	2 801	3 071	4 131	5 401	4 361	5 621	7 033	
PKTM III	ø 280	2 983	3 253	4 313	5 583	4 543	5 803	7 216	
PKTM III	ø 315	3 155	3 425	4 485	5 755	4 715	5 975	7 388	
PKTM III	ø 355	3 543	3 813	4 873	6 143	5 103	6 363	7 775	
PKTM III	ø 400	3 977	4 247	5 307	6 577	5 537	6 797	9 518	
PKTM III	ø 450	4 278	4 548	5 608	6 878	5 838	7 098	9 818	
PKTM III	ø 500	4 768	5 038	6 098	7 368	6 328	7 588	10 309	
PKTM III	ø 560	5 293	5 563	6 623	7 893	6 853	8 113	10 834	
PKTM III	ø 630	5 818	6 088	7 148	8 418	7 378	8 638	11 359	
PKTM 90	ø 710	8 219	8 489	9 549	10 819	9 779	11 039	14 547	
PKTM 90	ø 800	9 609	9 879	10 939	12 209	11 169	12 429	15 937	
PKTM 90	ø 900	16 657	16 927	17 987	19 257	18 217	19 477	22 985	
PKTM 90	ø 1 000	21 296	21 566	22 626	23 896	22 856	24 116	27 624	

	Klapka	Rozměr (mm)	Provedení a cena v Kč							
			.41/.61	.50	.51	.60	.62	.80	.82	.83/.84
	PKTM 90	1 500 × 600	22 135	13 326	19 533	16 501	17 937	8 719	9 659	10 959
	PKTM 90	1 500 × 630	22 135	13 326	19 533	16 501	17 937	8 719	9 659	10 959
	PKTM 90	1 500 × 650	22 262	13 453	19 660	16 627	18 064	8 846	9 786	11 086
	PKTM 90	1 500 × 710	22 636	13 827	20 034	17 001	18 438	9 220	10 160	11 460
	PKTM 90	1 500 × 750	22 877	14 068	20 275	17 242	18 679	9 461	10 401	11 701
	PKTM 90	1 500 × 800	23 198	14 388	20 595	17 563	19 000	9 782	10 722	12 022
	PKTM 90	1 500 × 900	23 821	15 011	21 218	18 186	19 622	10 405	11 345	12 645
	PKTM 90	1 500 × 1 000	24 433	15 623	21 830	18 798	20 234	11 017	11 957	13 257
	PKTM 90	1 600 × 200	22 458	13 648	19 855	16 823	18 260	9 042	9 982	11 282
	PKTM 90	1 600 × 250	22 458	13 648	19 855	16 823	18 260	9 042	9 982	11 282
	PKTM 90	1 600 × 315	22 458	13 648	19 855	16 823	18 260	9 042	9 982	11 282
	PKTM 90	1 600 × 355	22 458	13 648	19 855	16 823	18 260	9 042	9 982	11 282
	PKTM 90	1 400 × 400	22 458	13 648	19 855	16 823	18 260	9 042	9 982	11 282
	PKTM 90	1 600 × 450	22 458	13 648	19 855	16 823	18 260	9 042	9 982	11 282
	PKTM 90	1 600 × 500	22 458	13 648	19 855	16 823	18 260	9 042	9 982	11 282
	PKTM 90	1 600 × 550	22 458	13 648	19 855	16 823	18 260	9 042	9 982	11 282
	PKTM 90	1 600 × 560	22 458	13 648	19 855	16 823	18 260	9 042	9 982	11 282
	PKTM 90	1 600 × 600	22 458	13 648	19 855	16 823	18 260	9 042	9 982	11 282
	PKTM 90	1 600 × 630	22 458	13 648	19 855	16 823	18 260	9 042	9 982	11 282
	PKTM 90	1 600 × 650	22 591	13 782	19 989	16 957	18 393	9 175	10 115	11 415
	PKTM 90	1 600 × 710	22 591	13 782	19 989	16 957	18 393	9 175	10 115	11 415
	PKTM 90	1 600 × 750	22 985	14 176	20 383	17 350	18 787	9 569	10 509	11 809
	PKTM 90	1 600 × 800	23 239	14 429	20 636	17 604	19 041	9 823	10 763	12 063
	PKTM 90	1 600 × 900	23 576	14 767	20 974	17 941	19 378	10 160	11 100	12 400
	PKTM 90	1 600 × 900	24 232	15 422	21 629	18 597	20 034	10 816	11 756	13 056
	PKTM 90	1 600 × 1000	24 877	16 067	22 274	19 242	20 678	11 461	12 401	13 701
	PKTM III	ø 160	15 874	6 649	13 269	9 390	11 410	3 378	4 318	5 618
	PKTM III	ø 180	15 797	6 572	13 192	9 312	11 333	3 301	4 241	5 541
	PKTM III	ø 200	15 864	6 639	13 259	9 379	11 400	3 367	4 307	5 607
	PKTM III	ø 225	15 974	6 749	13 369	9 490	11 510	3 478	4 418	5 718
	PKTM III	ø 250	16 147	6 922	13 542	9 662	11 683	3 651	4 591	5 891
	PKTM III	ø 280	16 330	7 105	13 725	9 845	11 866	3 833	4 773	6 073
	PKTM III	ø 315	16 502	7 277	13 897	10 017	12 038	4 005	4 945	6 245
	PKTM III	ø 355	16 889	7 664	14 284	10 404	12 425	4 393	5 333	6 633
	PKTM III	ø 400	18 243	8 890	15 641	11 761	12 860	4 827	5 767	7 067
	PKTM III	ø 450	18 544	9 191	15 941	12 061	13 160	5 128	6 068	7 368
	PKTM III	ø 500	19 034	9 681	16 432	12 552	13 650	5 618	6 558	7 858
	PKTM III	ø 560	19 559	10 206	16 956	13 077	14 175	6 143	7 083	8 383
	PKTM III	ø 630	20 084	10 731	17 482	13 602	14 701	6 668	7 608	8 908
	PKTM 90	ø 710	22 485	13 676	19 883	16 850	18 287	9 069	10 009	11 309
	PKTM 90	ø 800	23 875	15 065	21 272	18 240	19 676	10 459	11 399	12 699
	PKTM 90	ø 900	30 923	22 113	28 320	25 288	26 725	17 507	18 447	19 747
	PKTM 90	ø 1 000	35 562	26 752	32 959	29 927	31 363	22 146	23 086	24 386

Provedení klapek	Dvojičíslo za TPM
Ruční teplotní	.01
Ruční a teplotní (ZÓNA 1, 2)	.02
Ruční a teplotní s koncovým spínačem („ZAVŘENO“)	.11
Ruční a teplotní s koncovým spínačem („ZAVŘENO“) (ZÓNA 1, 2)	.12
Ruční a teplotní s elektromagnetem AC 230 V (stř.)	.20
Ruční a teplotní s elektromagnetem AC 24 V (stř.)	.21
Ruční a teplotní s elektromagnetem DC 24 V (ss)	.22
Ruční a teplotní s elektromagnetem AC 230 V s koncovým spínačem („ZAVŘENO“) (stř.)	.23
Ruční a teplotní s elektromagnetem AC 24 V s koncovým spínačem („ZAVŘENO“) (stř.)	.24
Ruční a teplotní s elektromagnetem DC 24 V s koncovým spínačem („ZAVŘENO“) (ss)	.25
Ruční a teplotní s elektromagnetem AC 230 V s koncovým spínačem (zóna 2) (stř.)	.30
Ruční a teplotní s elektromagnetem AC 230 V s koncovým spínačem („ZAVŘENO“) (ZÓNA 2) (stř.)	.33
Se servopohonem BF 230-T (BLF 230-T)	.40
Se servopohonem BF 24-T (BLF 24-T) s optickým hlásičem kouře MHG 231 a napájecí jednotkou BKN 230 - 24 - MA (napětí sestavy AC 230 V)	.41
Se servopohonem ExMax -15 - BF AC 230 V s termoelektrickým aktivačním zařízením (ZÓNA 1, 2)	.42
Se servopohonem BF 24-T (BLF 24-T)	.50
Se servopohonem BF 24-T (BLF 24-T) - a s optickým hlásičem kouře MHG 231 (napětí sestavy AC/DC 24 V)	.51
Se servopohonem ExMax -15 - BF AC /DC s termoelektrickým aktivačním zařízením (ZÓNA 1, 2)	.52
S komunikačním a napájecím zařízením BKN 230-24 a se servopohonem BF 24-T-ST (BLF 24-T-ST)	.60
S komunikačním a napájecím zařízením BKN 230-24-MA se servopohonem BF 24-T-ST (BLF 24-T-ST) a s optickým hlásičem kouře MHG 231	.61
S komunikačním a napájecím zařízením BKN 230-24-MP a se servopohonem BF 24-TL-T-ST (Top-line) pro připojení na MP-Bus	.62
S komunikačním a napájecím zařízením BKN 230-24-LON a se servopohonem BF 24TL-T-ST (Top-line) pro připojení na Lon Works	.64
Ruční a teplotní se dvěma s koncovými spínači („ZAVŘENO - ZAVŘENO“)	.80
Ruční a teplotní se dvěma s koncovými spínači („ZAVŘENO - ZAVŘENO“) (ZÓNA 1, 2)	.81
Ruční, teplotní a s elektromagnetem AC 230 V se dvěma s koncovými spínači („ZAVŘENO - ZAVŘENO“) (stř.)	.82
Ruční, teplotní a s elektromagnetem AC 24 V se dvěma s koncovými spínači („ZAVŘENO - ZAVŘENO“) (stř.)	.83
Ruční, teplotní a s elektromagnetem DC 24 V se dvěma s koncovými spínači („ZAVŘENO - ZAVŘENO“) (ss)	.84
Ruční, teplotní a s elektromagnetem AC 230 V se dvěma s koncovými spínači („ZAVŘENO - ZAVŘENO“) (ZÓNA 2) (stř.)	.85

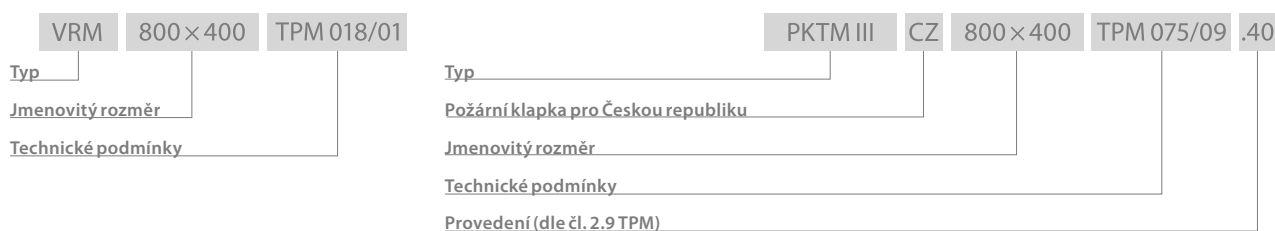
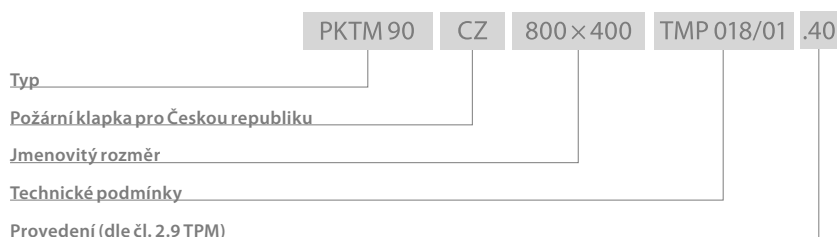

KOKTM (TPM 067/07)

Klapka odvodu kouře a tepla



KOKTM – Klapka odvodu kouře a tepla			
Rozměr (mm)	Provedení a cena v Kč		
	.44	.54	.66
180 × 180	10 644	9 236	12 348
180 × 200	10 681	9 272	12 384
180 × 250	10 769	9 361	12 473
200 × 180	10 682	9 274	12 386
200 × 200	10 720	9 312	12 424
200 × 250	10 813	9 404	12 516
200 × 300	10 908	9 500	12 612
200 × 315	10 938	9 530	12 642
200 × 355	11 009	9 600	12 713
200 × 400	11 094	9 686	12 798
200 × 450	11 189	9 780	12 893
200 × 500	11 285	9 876	12 988
200 × 550	11 378	9 970	13 082
200 × 560	11 397	9 988	13 100
200 × 630	11 528	10 119	13 232
200 × 650	11 566	10 157	13 270
200 × 710	11 682	10 273	13 386
200 × 750	11 756	10 347	13 460
200 × 800	11 852	10 443	13 555
200 × 900	12 038	10 629	13 742
200 × 1 000	12 511	11 103	14 170
250 × 180	10 771	9 363	12 475
250 × 200	10 813	9 404	12 517
250 × 250	10 914	9 506	12 618
250 × 300	11 019	9 610	12 723
250 × 315	11 052	9 643	12 755
250 × 355	11 130	9 721	12 833
250 × 400	11 223	9 815	12 927
250 × 450	11 327	9 918	13 030
250 × 500	11 432	10 023	13 135
250 × 550	11 534	10 126	13 238
250 × 560	11 554	10 146	13 258
250 × 630	11 699	10 290	13 402
250 × 650	11 740	10 331	13 444
250 × 710	11 867	10 458	13 571

KOKTM – Klapka odvodu kouře a tepla			
Rozměr (mm)	Provedení a cena v Kč		
	.44	.54	.66
250 × 750	11 948	10 540	13 652
250 × 800	12 053	10 644	13 756
250 × 900	12 257	10 849	13 961
250 × 1 000	12 749	11 340	14 408
300 × 200	10 905	9 496	12 609
300 × 250	11 015	9 607	12 719
300 × 300	11 129	9 720	12 833
300 × 315	11 164	9 756	12 868
300 × 355	11 250	9 841	12 953
300 × 400	11 351	9 943	13 055
300 × 450	11 464	10 055	13 167
300 × 500	11 578	10 169	13 281
300 × 550	11 689	10 281	13 393
300 × 560	11 711	10 303	13 415
300 × 630	11 868	10 459	13 572
300 × 650	11 913	10 505	13 617
300 × 710	12 051	10 642	13 755
300 × 750	12 140	10 731	13 843
300 × 800	12 253	10 844	13 957
300 × 900	12 765	11 356	14 423
300 × 1 000	12 985	11 577	14 644
315 × 200	10 932	9 524	12 636
315 × 250	11 046	9 637	12 749
315 × 300	11 162	9 753	12 866
315 × 315	11 198	9 789	12 902
315 × 355	11 285	9 856	12 989
315 × 400	11 390	9 981	13 093
315 × 450	11 505	10 096	13 209
315 × 500	11 621	10 213	13 325
315 × 550	11 736	10 327	13 440
315 × 560	11 759	10 350	13 462
315 × 630	11 919	10 510	13 623
315 × 650	11 965	10 557	13 669
315 × 710	12 106	10 698	13 810
315 × 750	12 197	10 788	13 901
315 × 800	12 313	10 905	14 017
315 × 900	12 830	11 422	14 489
315 × 1 000	13 056	11 648	14 715
355 × 200	11 006	9 598	12 710
355 × 250	11 127	9 718	12 830
355 × 300	11 250	9 842	12 954

KOKTM – Klapka odvodu kouře a tepla			
Rozměr (mm)	Provedení a cena v Kč		
	.44	.54	.66
355 × 315	11 289	9 880	12 992
355 × 355	11 382	9 973	13 085
355 × 400	11 493	10 084	13 196
355 × 450	11 615	10 206	13 319
355 × 500	11 739	10 330	13 443
355 × 550	11 861	10 452	13 564
355 × 560	11 885	10 476	13 588
355 × 630	12 055	10 647	13 759
355 × 650	12 104	10 696	13 808
355 × 710	12 254	10 846	13 958
355 × 750	12 351	10 942	14 054
355 × 800	12 474	11 065	14 178
355 × 900	13 006	11 597	14 664
355 × 1 000	13 246	11 837	14 905
400 × 200	11 090	9 682	12 794
400 × 250	11 219	9 810	12 922
400 × 300	11 350	9 942	13 054
400 × 315	11 391	9 983	13 095
400 × 355	11 491	10 082	13 195
400 × 400	11 609	10 200	13 313
400 × 450	11 740	10 331	13 443
400 × 500	11 872	10 463	13 575
400 × 550	12 001	10 593	13 705
400 × 560	12 027	10 618	13 731
400 × 630	12 209	10 800	13 913
400 × 650	12 262	10 853	13 965
400 × 710	12 421	11 012	14 125
400 × 750	12 524	11 115	14 228
400 × 800	12 945	11 536	14 603
400 × 900	13 203	11 795	14 862
400 × 1 000	13 460	12 051	15 119
450 × 200	11 185	9 776	12 889
450 × 250	11 322	9 914	13 026
450 × 300	11 463	10 055	13 167
450 × 315	11 507	10 098	13 211
450 × 355	11 614	10 205	13 318
450 × 400	11 740	10 331	13 444
450 × 450	11 880	10 471	13 583
450 × 500	12 021	10 612	13 724
450 × 550	12 160	10 751	13 863
450 × 560	12 187	10 778	13 891

KOKTM – Klapka odvodu kouře a tepla			
Rozměr (mm)	Provedení a cena v Kč		
	.44	.54	.66
450 × 630	12 382	10 973	14 085
450 × 650	12 438	11 029	14 141
450 × 710	12 608	11 199	14 312
450 × 750	13 007	11 599	14 666
450 × 800	13 148	11 739	14 807
450 × 900	13 425	12 016	15 084
450 × 1 000	13 700	12 291	15 359
500 × 200	11 278	9 869	12 982
500 × 250	11 424	10 016	13 128
500 × 300	11 574	10 166	13 278
500 × 315	11 620	10 212	13 324
500 × 355	11 735	10 326	13 438
500 × 400	11 869	10 460	13 573
500 × 450	12 018	10 609	13 721
500 × 500	12 168	10 759	13 871
500 × 550	12 316	10 907	14 019
500 × 560	12 345	10 936	14 049
500 × 630	12 552	11 144	14 256
500 × 650	12 612	11 203	14 316
500 × 710	13 082	11 674	14 741
500 × 750	13 200	11 791	14 858
500 × 800	13 349	11 941	15 008
500 × 900	13 644	12 236	15 303
500 × 1 000	13 937	12 529	15 596
550 × 200	11 370	9 961	13 074
550 × 250	11 525	10 117	13 229
550 × 300	11 684	10 276	13 388
550 × 315	11 733	10 325	13 437
550 × 355	11 855	10 446	13 558
550 × 400	11 997	10 588	13 701
550 × 450	12 155	10 746	13 859
550 × 500	12 314	10 905	14 018
550 × 550	12 471	11 062	14 175
550 × 560	12 502	11 093	14 206
550 × 630	12 722	11 313	14 426
550 × 650	13 074	11 666	14 733
550 × 710	13 266	11 858	14 925
550 × 750	13 391	11 982	15 050
550 × 800	13 550	12 141	15 209
550 × 900	13 863	12 454	15 522
550 × 1 000	14 174	12 765	15 833

KOKTM – Klapka odvodu kouře a tepla			
Rozměr (mm)	Provedení a cena v Kč		
	.44	.54	.66
560 × 200	11 391	9 983	13 095
560 × 250	11 549	10 140	13 252
560 × 300	11 710	10 301	13 413
560 × 315	11 759	10 350	13 463
560 × 355	11 882	10 473	13 586
560 × 400	12 026	10 617	13 730
560 × 450	12 186	10 777	13 889
560 × 500	12 346	10 938	14 050
560 × 550	12 505	11 097	14 209
560 × 560	12 537	11 128	14 240
560 × 630	12 759	11 351	14 463
560 × 650	13 112	11 704	14 771
560 × 710	13 307	11 898	14 965
560 × 750	13 433	12 024	15 092
560 × 800	13 593	12 184	15 252
560 × 900	13 910	12 501	15 569
560 × 1 000	14 225	12 816	15 883
600 × 200	11 466	10 057	13 170
600 × 250	11 631	10 222	13 334
600 × 300	11 799	10 390	13 502
600 × 315	11 851	10 442	13 555
600 × 355	11 979	10 570	13 683
600 × 400	12 130	10 721	13 833
600 × 450	12 296	10 888	14 000
600 × 500	12 465	11 056	14 168
600 × 550	12 631	11 222	14 334
600 × 560	12 663	11 255	14 367
600 × 630	13 185	11 776	14 844
600 × 650	13 252	11 843	14 911
600 × 710	13 455	12 046	15 114
600 × 750	13 587	12 178	15 246
600 × 800	13 755	12 346	15 414
600 × 900	14 086	12 677	15 745
600 × 1 000	14 415	13 006	16 074
630 × 200	11 521	10 112	13 225
630 × 250	11 691	10 282	13 395
630 × 300	11 846	10 456	13 568
630 × 315	11 918	10 509	13 622
630 × 355	12 051	10 642	13 755
630 × 400	12 206	10 798	13 910
630 × 450	12 379	10 970	14 082

KOKTM – Klapka odvodu kouře a tepla			
Rozměr (mm)	Provedení a cena v Kč		
	.44	.54	.66
630 × 500	12 552	11 143	14 256
630 × 550	12 724	11 315	14 427
630 × 560	12 758	11 349	14 461
630 × 630	13 287	11 878	14 946
630 × 650	13 356	11 947	15 015
630 × 710	13 565	12 157	15 224
630 × 750	13 702	12 293	15 361
630 × 800	13 875	12 466	15 534
630 × 900	14 217	12 808	15 876
630 × 1 000	14 557	13 148	16 216
710 × 250	11 855	10 446	13 558
710 × 300	12 042	10 634	13 746
710 × 315	12 100	10 691	13 804
710 × 355	12 245	10 836	13 948
710 × 400	12 413	11 004	14 117
710 × 450	12 600	11 191	14 304
710 × 500	13 077	11 668	14 736
710 × 550	13 263	11 854	14 922
710 × 560	13 300	11 891	14 959
710 × 630	13 560	12 152	15 219
710 × 650	13 635	12 226	15 294
710 × 710	13 862	12 453	15 521
710 × 750	14 010	12 601	15 669
710 × 800	14 197	12 789	15 856
710 × 900	14 568	13 160	16 227
710 × 1 000	14 937	13 529	16 596
750 × 250	11 934	10 525	13 638
750 × 300	12 129	10 720	13 833
750 × 315	12 189	10 780	13 893
750 × 355	12 339	10 931	14 043
750 × 400	12 514	11 106	14 218
750 × 450	12 997	11 589	14 656
750 × 500	13 193	11 784	14 851
750 × 550	13 386	11 977	15 045
750 × 560	13 424	12 015	15 083
750 × 630	13 695	12 286	15 354
750 × 650	13 772	12 364	15 431
750 × 710	14 008	12 599	15 667
750 × 750	14 162	12 753	15 820
750 × 800	14 356	12 948	16 015
750 × 900	14 742	13 333	16 401

KOKTM – Klapka odvodu kouře a tepla			
Rozměr (mm)	Provedení a cena v Kč		
	.44	.54	.66
750 × 1 000	15 125	13 717	16 784
800 × 250	12 043	10 634	13 747
800 × 300	12 247	10 838	13 951
800 × 315	12 310	10 901	14 013
800 × 355	12 467	11 059	14 171
800 × 400	12 939	11 531	14 598
800 × 450	13 142	11 734	14 801
800 × 500	13 347	11 938	15 006
800 × 550	13 549	12 140	15 208
800 × 560	13 589	12 180	15 248
800 × 630	13 872	12 464	15 531
800 × 650	13 954	12 545	15 613
800 × 710	14 200	12 791	15 859
800 × 750	14 361	12 952	16 020
800 × 800	14 565	13 156	16 224
800 × 900	14 999	13 590	16 658
800 × 1 000	15 400	13 992	17 059
900 × 315	12 828	11 419	14 487
900 × 355	13 000	11 591	14 659
900 × 400	13 200	11 791	14 858
900 × 450	13 421	12 012	15 080
900 × 500	13 643	12 234	15 302
900 × 550	13 863	12 455	15 522
900 × 560	13 907	12 498	15 566
900 × 630	14 216	12 807	15 875
900 × 650	14 304	12 896	15 963
900 × 710	14 572	13 164	16 231
900 × 750	14 748	13 339	16 407
900 × 800	14 970	13 561	16 629
900 × 900	15 440	14 031	17 099
900 × 1 000	15 878	14 469	17 536
1000 × 400	13 459	12 050	15 118
1000 × 450	13 698	12 289	15 357
1000 × 500	13 938	12 530	15 597
1000 × 550	14 177	12 768	15 836
1000 × 560	14 224	12 816	15 883
1000 × 630	14 558	13 150	16 217
1000 × 650	14 654	13 245	16 313
1000 × 710	14 944	13 535	16 603
1000 × 750	15 134	13 725	16 793
1000 × 800	15 374	13 965	17 033

KOKTM – Klapka odvodu kouře a tepla			
Rozměr (mm)	Provedení a cena v Kč		
	.44	.54	.66
1 000 × 900	15 880	14 471	17 539
1 000 × 1 000	16 354	14 945	18 013
1 100 × 400	13 718	12 309	15 377
1 100 × 450	13 975	12 567	15 634
1 100 × 500	14 234	12 825	15 893
1 100 × 550	14 491	13 082	16 149
1 100 × 560	14 542	13 133	16 200
1 100 × 630	14 901	13 492	16 560
1 100 × 650	15 004	13 595	16 663
1 100 × 710	15 315	13 907	16 974
1 100 × 750	15 520	14 111	17 179
1 100 × 800	15 778	14 369	17 437
1 100 × 900	16 320	14 912	17 979
1 100 × 1 000	16 830	15 422	18 489
1 250 × 500	14 711	13 302	16 370
1 250 × 550	14 994	13 586	16 653
1 250 × 560	15 051	13 642	16 710
1 250 × 630	15 448	14 039	17 107
1 250 × 650	15 562	14 153	17 221
1 250 × 710	15 906	14 497	17 565
1 250 × 750	16 132	14 723	17 791
1 250 × 800	16 417	15 009	18 076
1 250 × 900	16 984	15 575	18 643
1 250 × 1 000	17 548	16 139	19 207
1 400 × 500	15 151	13 742	16 810
1 400 × 550	15 462	14 053	17 121
1 400 × 560	15 523	14 115	17 182
1 400 × 630	15 959	14 550	17 618
1 400 × 650	16 084	14 675	17 742
1 400 × 710	16 460	15 052	18 119
1 400 × 750	16 708	15 299	18 367
1 400 × 800	17 020	15 612	18 679
1 400 × 900	17 641	16 232	19 300
1 400 × 1 000	18 260	16 851	19 919
1 500 × 500	15 450	14 041	17 109
1 500 × 550	15 779	14 370	17 437
1 500 × 560	15 844	14 435	17 503
1 500 × 630	16 305	14 896	17 964
1 500 × 650	16 437	15 028	18 096
1 500 × 710	16 835	15 426	18 494
1 500 × 750	17 097	15 689	18 756

KOKTM – Klapka odvodu kouře a tepla			
Rozměr (mm)	Provedení a cena v Kč		
	.44	.54	.66
1 500 × 800	17 428	16 019	19 087
1 500 × 900	18 085	16 676	19 743
1 500 × 1 000	18 739	17 331	20 398
1 600 × 630	16 649	15 241	18 308
1 600 × 650	16 789	15 380	18 447
1 600 × 710	17 209	15 800	18 868
1 600 × 750	17 485	16 077	19 144
1 600 × 800	17 834	16 425	19 493
1 600 × 900	18 527	17 118	20 186
1 600 × 1 000	19 218	17 809	20 877

KOKTM – Klapka odvodu kouře a tepla	
Typ ovládání	Provedení klapky
se servopohonem BE230-12	.44
se servopohonem BE24-12	.54
s komunikačním a síťovým přístrojem BKNE 230-24 a se servopohonem BE24-12st	.66

Typ	KOKTM – 120	400 × 400	TPM 067/07	.44
Jmenovitý rozměr				
Technické podmínky				
Provedení				

PSUM 90 (TPM 006/99)

Požární stěnový uzávěr

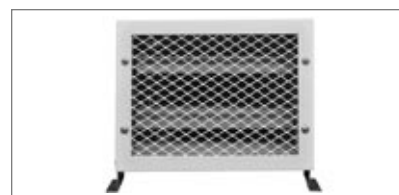

PSUM 90 – Požární stěnový uzávěr								
Rozměr (mm)	Provedení a cena v Kč							
	.01	.02	.11	.12	.40	.50	.41	.51
200×215	3 590	3 890	3 940	5 590	-	-	-	-
200×315	4 120	4 420	4 470	6 120	10 620	9 920	18 770	14 750
200×415	4 390	4 690	4 740	6 390	10 890	10 190	19 040	15 210
200×515	5 140	5 440	5 490	7 140	11 640	10 940	19 790	15 570
200×615	5 830	6 130	6 180	7 830	12 330	11 630	20 480	16 020
200×715	6 530	6 830	6 880	8 530	13 030	12 330	21 180	16 330
200×815	7 270	7 570	7 620	9 270	13 770	13 070	21 920	16 960
300×215	4 150	4 450	4 500	6 150	-	-	-	-
300×315	4 410	4 710	4 760	6 410	10 910	10 210	19 060	15 000
300×415	5 200	5 500	5 550	7 200	11 700	11 000	19 850	15 400
300×515	5 850	6 150	6 200	7 850	12 350	11 650	20 500	15 890
300×615	6 670	6 970	7 020	8 670	13 170	12 470	21 320	16 370
300×715	7 280	7 580	7 630	9 280	13 780	13 080	21 930	16 860
300×815	7 950	8 250	8 300	9 950	14 450	13 750	22 600	17 400
400×215	4 790	5 090	5 140	6 790	-	-	-	-
400×315	5 250	5 550	5 600	7 250	11 750	11 050	19 900	15 300
400×415	5 860	6 160	6 210	7 860	12 360	11 660	20 510	15 640
400×515	6 720	7 020	7 070	8 720	13 220	12 520	21 370	16 240
400×615	7 390	7 690	7 740	9 390	13 890	13 190	22 040	16 760
400×715	7 980	8 280	8 330	9 980	14 480	13 780	22 630	17 320
400×815	8 530	8 830	8 880	10 530	15 030	14 330	23 180	17 940
500×215	5 470	5 770	5 820	7 470	-	-	-	-
500×315	6 210	6 510	6 560	8 210	12 710	12 010	20 860	15 350
500×415	6 860	7 160	7 210	8 860	13 360	12 660	22 510	15 930
500×515	7 720	8 020	8 070	9 720	14 220	13 520	22 370	16 560
500×615	7 990	8 290	8 340	9 990	14 490	13 790	22 640	17 160
500×715	8 570	8 870	8 920	10 570	15 070	14 370	23 220	17 790
500×815	8 910	9 210	9 260	10 910	15 410	14 710	23 560	18 410
600×215	6 580	6 880	6 930	8 580	-	-	-	-
600×315	7 170	7 470	7 520	9 170	13 670	12 970	21 820	15 590
600×415	7 450	7 750	7 800	9 450	13 950	13 250	22 100	16 220
600×515	8 190	8 490	8 540	10 190	14 690	13 990	22 840	16 870
600×615	8 640	8 940	8 990	10 640	15 140	14 440	23 290	17 500
600×715	9 080	9 380	9 430	11 080	15 580	14 880	23 730	18 160
600×815	9 710	10 010	10 060	11 710	16 210	15 510	24 360	18 850

Typ	PSUM 90	300×415	TPM 006/99	.40
Jmenovitý rozměr				
Technické podmínky				
Provedení				

PVM E90 (TPM 052/05)

Požární ventil



PVM E90 – Požární ventil		
Ventil	Rozměr (mm)	Cena v Kč
PVM-E90	ø 100	950
PVM-E90	ø 125	1 050
PVM-E90	ø 160	1 190
PVM-E90	ø 200	1 230

Typ	PVM-E90	ø 160	TPM 052/05
Jmenovitý rozměr			
Technické podmínky			

Provedení požárních stěnových uzávěrů PSUM 90	Dvojcísle za TPM
Ruční teplotní	.01
Ruční a teplotní (ZÓNA 1, 2)	.02
Ruční a teplotní s koncovým spínačem („ZAVŘENO“)	.11
Ruční a teplotní s koncovým spínačem („ZAVŘENO“) (ZÓNA 1, 2)	.12
Se servopohonem BF 230-T (BLF 230-T)	.40
Se servopohonem BF 24-T (BLF 24-T) s optickým hlásičem kouře MHG 231 a napájecí jednotkou BKN 230 - 24 - MA (napětí sestavy AC 230 V)	.41
Se servopohonem BF 24-T (BLF 24-T)	.50
Se servopohonem BF 24-T (BLF 24-T) - a s optickým hlásičem kouře MHG 231 (napětí sestavy AC/DC 24 V)	.51

VVM (TPM 001/96)

Vyúst s vířivým výtokem vzduchu



VVM – Vyúst s vířivým výtokem vzduchu							
Provedení		Rozměr (mm) a cena v Kč					
		300	400	500	600	625	825
C(K)/	V/P/8	1 514					
C(K)/	V/P/16		1 931	2 075	2 243	2 292	
C(K)/	V/P/24			2 636	3 071	3 101	
C(K)/	V/P/48				3 610	3 657	
C(K)/	V/P/54				3 620	3 667	
C(K)/	V/P/72						6 906
C(K)/	V/O/8	1 553					
C(K)/	V/O/16		1 962	2 106	2 274	2 323	
C(K)/	V/O/24			2 608	3 036	3 065	
C(K)/	V/O/48				3 761	3 808	
C(K)/	V/O/54				3 771	3 818	
C(K)/	V/O/72						6 791
C(K)/	V/P/8/R	1 590					
C(K)/	V/P/16/R		2 016	2 160	2 328	2 377	
C(K)/	V/P/24/R			2 731	3 158	3 188	
C(K)/	V/P/48/R				3 725	3 772	
C(K)/	V/P/54/R				3 735	3 782	
C(K)/	V/P/72/R						6 980
C(K)/	V/O/8/R	1 628					
C(K)/	V/O/16/R		2 047	2 191	2 359	2 408	
C(K)/	V/O/24/R			2 703	3 113	3 143	
C(K)/	V/O/48/R				3 867	3 914	
C(K)/	V/O/54/R				3 877	3 924	
C(K)/	V/O/72/R						6 911
C(K)/	S/P/8	2 402					
C(K)/	S/P/16		2 763	2 908	3 075	3 124	
C(K)/	S/P/24			3 597	4 028	4 058	
C(K)/	S/P/48				4 460	4 507	
C(K)/	S/P/54				4 470	4 517	
C(K)/	S/P/72						7 363
C(K)/	S/O/8	2 237					
C(K)/	S/O/16		2 576	2 720	2 888	2 937	
C(K)/	S/O/24			3 310	3 647	3 677	
C(K)/	S/O/48				3 969	4 017	
C(K)/	S/O/54				3 979	4 027	
C(K)/	S/O/72						6 623

VVM – Vyúst s vířivým výtokem vzduchu							
Provedení		Rozměr (mm) a cena v Kč					
		300	400	500	600	625	825
C(K)/	S/P/8/R	2 415					
C(K)/	S/P/16/R		2 776	2 921	3 089	3 138	
C(K)/	S/P/24/R			3 610	4 006	4 072	
C(K)/	S/P/48/R				4 481	4 918	
C(K)/	S/P/54/R				4 491	4 928	
C(K)/	S/P/72/R						7 586
C(K)/	S/O/8/R	2 250					
C(K)/	S/O/16/R		2 589	2 734	2 901	2 950	
C(K)/	S/O/24/R			3 324	3 661	3 691	
C(K)/	S/O/48/R				3 990	4 038	
C(K)/	S/O/54/R				4 000	4 048	
C(K)/	S/O/72/R						6 846

Samostatná čelní deska							
Provedení		Rozměr (mm) a cena v Kč					
		300	400	500	600	625	825
C(K)/	8 lamel	400					
C(K)/	16 lamel		630	774	942	967	
C(K)/	24 lamel			893	1 124	1 119	
C(K)/	48 lamel				1 390	1 438	
C(K)/	54 lamel				1 400	1 448	
C(K)/	72 lamel						2 501

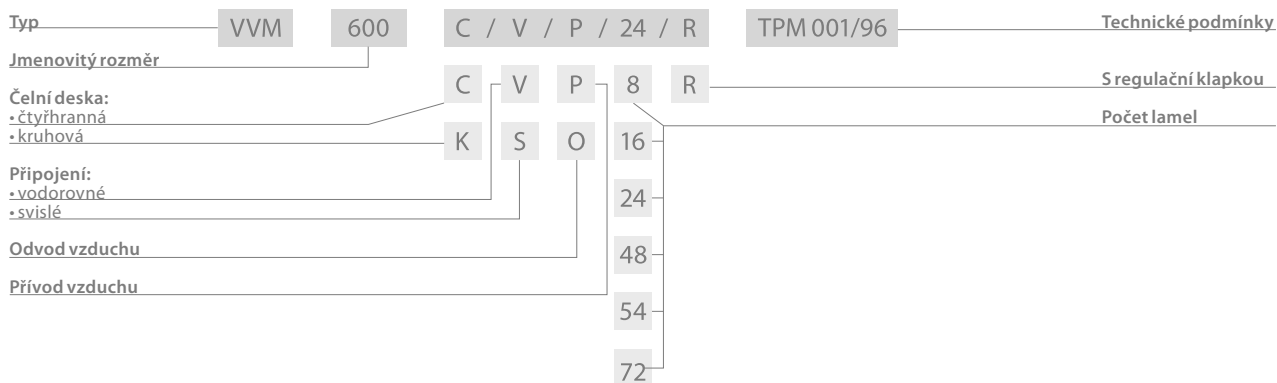

VVPM (TPM 007/99)

Vyúst' vířivá s pevnými lamelami

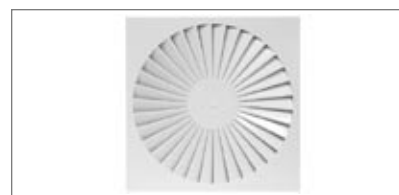

VVPM – Vyúst' vířivá s pevnými lamelami					
Provedení	Rozměr (mm) a cena v Kč				
	300	400	500	600	625
C/V/P	1 264	1 516	2 003	2 315	2 345
C/V/O	1 296	1 541	1 980	2 286	2 317
C/V/P/R	1 325	1 584	2 078	2 384	2 415
C/V/O/R	1 357	1 609	2 055	2 348	2 379
C/S/P	1 989	2 181	2 769	3 079	3 109
C/S/O	1 846	2 031	2 540	2 774	2 804
C/S/P/R	1 997	2 192	2 780	3 090	3 121
C/S/O/R	1 850	2 042	2 551	2 785	2 816

Samostatná čelní deska					
Provedení	Rozměr (mm) a cena v Kč				
	300	400	500	600	625
C/K	364	475	610	757	788

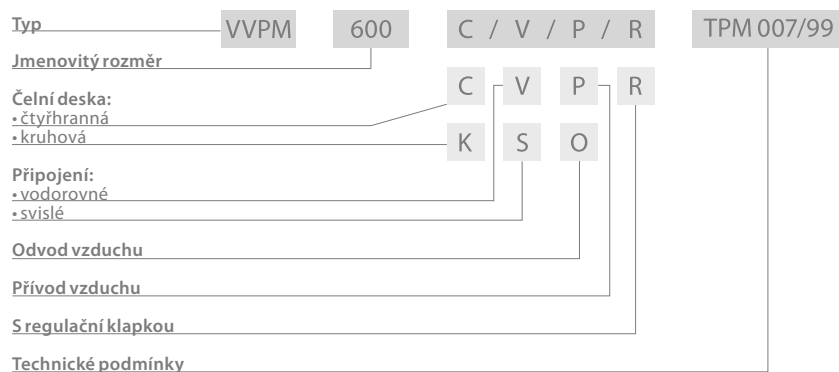

ALCM (TPM 003/97)

Anemostat lamelový čtvercový

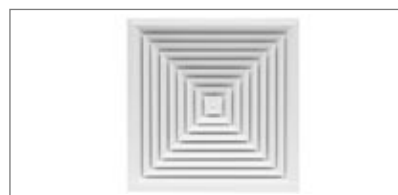

ALCM – Anemostat lamelový čtvercový						
Provedení základní I, L, U, H	Rozměr (mm) a cena v Kč					
	250	300	400	500	600	625
P	1 590	1 950	2 230	2 800	3 430	3 590
O	1 490	1 810	2 030	2 530	3 050	3 200
P/R	1 660	2 020	2 330	2 910	3 600	3 760
O/R	1 550	1 880	2 120	2 640	3 220	3 370
Z	960	1 360	1 640	2 070	2 540	2 960

Samostatná čelní deska						
Provedení	Rozměr (mm) a cena v Kč					
	250	300	400	500	600	625
základní I, L, U, H	420	720	850	1 110	1 400	1 540

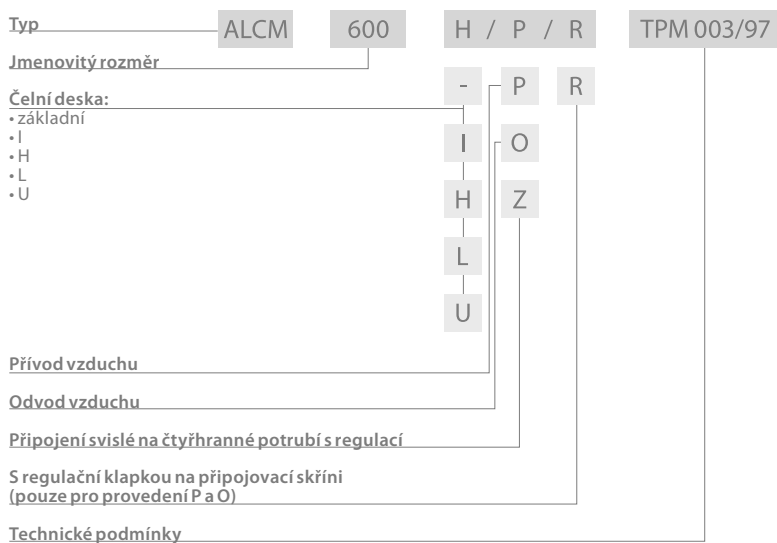

ALKM (TPM 005/99)

Anemostat lamelový kruhový



ALKM – Anemostat lamelový kruhový					
Provedení	Rozměr a cena v Kč				
	250	300	400	500	600
V/P	1 203	1 339	1 832	2 657	3 544
V/O	1 233	1 603	1 853	2 614	3 490
V/P/R	1 255	1 389	1 889	2 700	3 606
V/O/R	1 286	1 416	1 910	2 657	3 547
S/P	1 674	1 797	2 386	3 235	4 050
S/O	1 628	1 823	2 261	3 045	3 803
S/P/R	1 702	1 950	2 395	3 329	4 125
S/O/R	1 656	1 977	2 270	3 139	3 879

Samostatná čelní deska					
Provedení	Rozměr (mm) a cena v Kč				
	250	300	400	500	600
Čelní deska	444	589	965	1480	2112

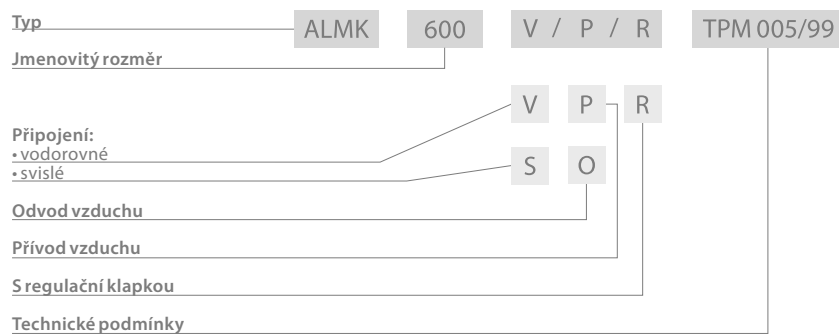

CHICAGO (TPM 036/05)

Pohledový anemostat



CHICAGO – Pohledový anemostat		
Provedení	Rozměr a cena v Kč	
	600	625
V/P/R	5 280	5 290
V/O/R	5 280	5 290
S/P/R	4 580	4 590
S/O/R	4 440	4 450
Z	4 690	4 700
J	3 880	3 890
Čelní deska	3 630	3 650

VASM (TPM 017/01)

Vířivý anemostat se stavitelnými lamelami



VASM – Vířivý anemostat se stavitelnými lamelami

Provedení	Rozměr (mm) a cena v Kč		
	315	400	630
V.01	3 376	4 684	11 224
V.45	6 262	7 587	14 712
V.46	6 778	8 104	14 880
V.55	6 391	7 716	14 654
V.56	6 716	7 951	15 417
V.57	6 831	8 177	16 418
S.01	3 694	5 036	11 058
S.45	6 578	7 939	15 127
S.46	7 096	8 456	15 303
S.55	6 709	8 068	15 068
S.56	7 033	8 303	15 861
S.57	7 259	8 529	16 902

Samostná čelní deska

Provedení	Rozměr (mm) a cena v Kč		
	315	400	630
ČD.01	2032	3055	8448
ČD.45	4840	5883	11896
ČD.46	5356	6400	12064
ČD.55	4969	6012	11838
ČD.56	5203	6247	12601
ČD.57	5430	6473	13602

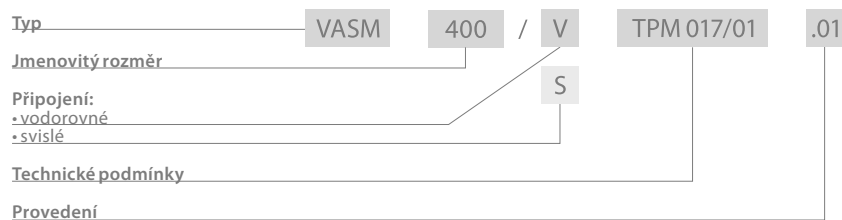

VAPM (TPM 010/00)

Vířivý anemostat s pevnými lamelami



VAPM – Vířivý anemostat s pevnými lamelami						
Provedení	Rozměr (mm) a cena v Kč					
	125	160	200	250	315	400
C/V/P	1 264	1 402	1 450	1 806	1 935	2 442
C/D/V/P	1 404	1 561	1 678	2 101	2 227	2 928
K/V/P	1 233	1 366	1 443	1 765	1 852	2 270
K/D/V/P	1 365	1 533	1 621	2 075	2 372	3 163
C/V/O	1 256	1 392	1 438	1 735	1 862	2 171
C/D/V/O	1 396	1 551	1 666	2 031	2 154	2 657
K/V/O	1 225	1 356	1 431	1 694	1 779	1 999
K/D/V/O	1 357	1 523	1 609	2 004	2 299	2 892
C/V/P/R	1 318	1 457	1 503	1 884	1 989	2 521
C/D/V/P/R	1 458	1 615	1 731	2 180	2 281	3 007
K/V/P/R	1 287	1 421	1 495	1 843	1 906	2 349
K/D/V/P/R	1 419	1 588	1 674	2 153	2 426	3 242
C/V/O/R	1 310	1 447	1 491	1 814	1 914	2 442
C/D/V/O/R	1 450	1 606	1 719	2 109	2 206	2 929
K/V/O/R	1 279	1 411	1 483	1 772	1 831	2 270
K/D/V/O/R	1 411	1 578	1 662	2 082	2 351	3 164
C/S/P	1 715	1 788	1 908	1 989	2 138	2 667
C/D/S/P	1 855	1 947	2 135	2 285	2 430	3 153
K/S/P	1 684	1 753	1 900	1 948	2 054	2 495
K/D/S/P	1 818	1 922	2 078	2 258	2 574	3 388
C/S/O	1 396	1 788	1 801	1 879	2 024	2 480
C/D/S/O	1 523	1 947	2 028	2 174	2 316	2 966
K/S/O	1 684	1 753	1 793	1 837	1 940	2 308
K/D/S/O	1 488	1 920	1 971	2 147	2 460	3 201
C/S/P/R	1 741	1 802	1 816	2 084	2 321	2 791
C/D/S/P/R	1 881	1 961	2 043	2 379	2 614	3 278
K/S/P/R	1 710	1 767	1 808	2 042	2 238	2 619
K/D/S/P/R	1 842	1 934	1 987	2 352	2 758	3 512
C/S/O/R	1 783	1 846	1 779	2 015	2 229	2 660
C/D/S/O/R	1 923	2 005	2 007	2 310	2 521	3 147
K/S/O/R	1 752	1 811	1 771	1 973	2 145	2 488
K/D/S/O/R	1 885	1 977	1 950	2 283	2 666	3 382
K/D/T/P	1 335	1 538	1 649	2 014	2 538	3 502
K/D/T/P/R	1 379	1 578	1 690	2 075	2 613	3 583
K/D/T/O	1 234	1 416	1 501	1 822	2 275	3 160
K/D/T/O/R	1 281	1 460	1 545	1 889	2 346	3 241

Samostatná čelní deska						
Provedení	Rozměr (mm) a cena v Kč					
	125	160	200	250	315	400
C	304	350	372	427	569	755
C/D	439	502	590	711	850	1 223
K	274	315	364	387	489	590
K/D	401	476	536	686	989	1 449

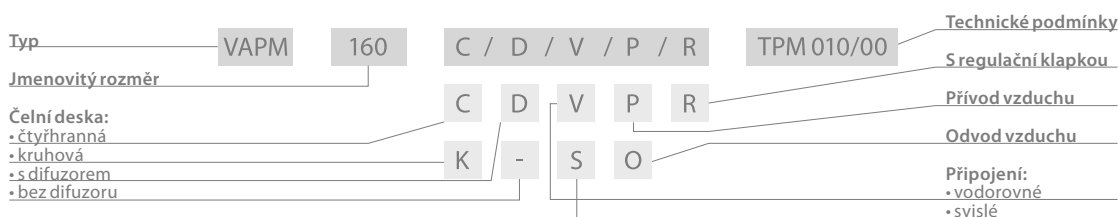

RKM (TPM 009/00)

Regulační klapka



RKM – Regulační klapka						
Rozměr (mm)	Provedení a cena v Kč					
	.01/.09	.45	.46	.55	.56	.57
200 × 200	842	2 687	2 902	2 650	3 125	3 110
200 × 250	898	2 745	2 960	2 708	3 183	3 168
200 × 315	1 008	2 860	3 075	2 823	3 298	3 283
200 × 400	1 098	2 953	3 169	2 917	3 392	3 377
200 × 500	1 248	3 370	4 025	3 384	3 973	4 531
250 × 200	861	2 707	2 922	2 670	3 145	3 130
250 × 250	920	2 768	2 983	2 731	3 206	3 191
250 × 315	1 031	2 884	3 099	2 847	3 322	3 307
250 × 400	1 123	2 979	3 194	2 942	3 417	3 402
250 × 500	1 275	3 434	4 053	3 412	4 001	4 559
250 × 630	1 445	3 611	4 230	3 589	4 178	4 736
315 × 200	889	2 735	2 951	2 699	3 174	3 159
315 × 250	951	2 800	3 016	2 764	3 239	3 224
315 × 315	1 065	2 919	3 134	2 882	3 357	3 342
315 × 400	1 160	3 017	3 233	2 981	3 456	3 441
315 × 500	1 316	3 477	4 096	3 455	4 044	4 602
315 × 630	1 494	3 661	4 281	3 640	4 229	4 785
315 × 800	1 766	3 945	4 564	3 923	4 512	5 070
400 × 200	925	2 773	2 989	2 737	3 212	3 197
400 × 250	992	2 843	3 059	2 807	3 282	3 267
400 × 315	1 109	2 965	3 181	2 929	3 403	3 389
400 × 400	1 208	3 067	3 283	3 031	3 506	3 491
400 × 500	1 370	3 533	4 152	3 511	4 100	4 658
400 × 630	1 620	3 793	4 412	3 771	4 360	4 918
400 × 800	1 838	4 019	4 639	3 998	4 586	5 145
400 × 1 000	2 136	4 970	5 704	4 874	5 140	6 126
500 × 200	996	2 847	3 063	2 811	3 286	3 271
500 × 250	1 069	2 923	3 138	2 886	3 361	3 346
500 × 315	1 190	3 049	3 265	3 013	3 487	3 473
500 × 400	1 285	3 148	3 363	3 111	3 586	3 571
500 × 500	1 497	3 665	4 284	3 643	4 232	4 790
500 × 630	1 695	3 871	4 490	3 849	4 438	4 996
500 × 800	1 923	4 108	4 727	4 086	4 675	5 233
500 × 1 000	2 235	5 073	5 808	4 977	5 244	6 230
500 × 1 250	2 633	5 487	6 221	5 391	5 657	6 644
630 × 200	1 047	2 900	3 116	2 864	3 338	3 324
630 × 250	1 127	2 984	3 199	2 947	3 422	3 407

RKM– Regulační klapka						
Rozměr (mm)	Provedení a cena v Kč					
	.01/09	.45	.46	.55	.56	.57
630×315	1 253	3 114	3 329	3 077	3 552	3 537
630×400	1 424	3 292	3 508	3 256	3 730	3 716
630×500	1 573	3 743	4 363	3 722	4 311	4 869
630×630	1 783	3 963	4 582	3 941	4 530	5 088
630×800	2 023	4 211	4 831	4 190	4 779	5 362
630×1 000	2 351	5 194	5 928	5 098	5 364	6 350
630×1 250	2 775	5 635	6 369	5 538	5 805	6 791
630×1 400	3 041	5 912	6 646	5 816	6 082	7 577
800×200	1 125	2 981	3 197	2 945	3 420	3 405
800×250	1 282	3 144	3 360	3 108	3 583	3 568
800×315	1 414	3 282	3 497	3 242	3 720	3 705
800×400	1 525	3 397	3 613	3 361	3 836	3 821
800×500	1 685	3 860	4 480	3 839	4 428	4 986
800×630	1 914	4 099	4 718	4 077	4 666	5 224
800×800	2 170	4 365	4 984	4 343	4 932	5 515
800×1 000	2 522	5 371	6 105	5 275	5 541	6 528
800×1 250	3 048	5 919	6 653	5 822	6 089	7 075
800×1 400	3 261	6 140	6 874	6 044	6 310	7 805
800×1 600	3 580	6 472	7 206	5 346	6 642	8 209
800×1 800	3 900	6 805	7 539	6 709	6 975	8 614
800×2 000	4 219	7 137	7 871	7 040	7 307	9 018
1 000×200	1 297	3 160	3 376	3 124	3 599	3 584
1 000×250	1 398	3 266	3 481	3 229	3 704	2 946
1 000×315	1 542	3 415	3 631	3 379	3 854	3 102
1 000×400	1 661	3 539	3 754	3 502	3 977	3 962
1 000×500	1 835	4 016	4 636	3 995	4 584	5 142
1 000×630	2 090	4 281	4 901	4 260	4 849	5 407
1 000×800	2 361	4 563	5 183	4 542	5 131	5 689
1 000×1 000	2 717	5 574	6 308	5 478	5 744	6 730
1 000×1 250	3 281	6 161	6 895	6 065	6 331	7 317
1 000×1 400	3 537	6 427	7 161	6 331	6 597	8 093
1 000×1 600	3 883	6 788	7 518	6 691	6 958	8 525
1 000×1 800	4 231	7 149	7 883	7 053	7 319	8 958
1 000×2 000	4 800	7 741	8 475	7 645	7 911	9 622
1 250×400	1 797	3 977	4 596	3 955	4 544	5 102
1 250×500	1 986	4 173	4 793	4 152	4 741	5 162
1 250×630	2 262	4 460	5 079	4 438	5 027	5 585
1 250×800	2 621	5 475	6 209	5 379	5 645	6 631
1 250×1000	3 007	5 876	6 610	5 780	6 046	7 033
1 250×1250	3 557	6 449	7 183	6 352	6 619	7 605
1 250×1400	3 830	6 732	7 466	6 636	6 902	8 397
1 250×1600	4 206	7 124	7 854	7 027	7 294	8 861
1 250×1800	4 807	7 748	8 482	7 652	7 918	9 557

RKM – Regulační klapka						
Rozměr (mm)	Provedení a cena v Kč					
	.01/09	.45	.46	.55	.56	.57
1 250 × 2 000	5 184	8 140	8 874	8 044	8 310	10 021
1 400 × 500	3 099	7 402	8 637	7 358	8 536	9 653
1 400 × 630	3 590	7 912	9 147	7 868	9 046	10 163
1 400 × 800	4 067	8 408	9 644	8 221	9 543	10 659
1 400 × 1 000	4 674	10 322	11 786	10 129	10 662	12 634
1 400 × 1 250	5 507	11 201	12 652	10 995	11 528	13 500
1 400 × 1 400	5 952	11 651	13 116	11 458	11 991	13 964
1 400 × 1 600	6 773	12 504	13 969	12 311	12 844	14 817
1 400 × 1 800	7 370	13 126	14 590	12 933	13 466	15 438
1 400 × 2 000	7 969	13 748	15 213	13 556	14 089	16 061
1 600 × 630	3 734	8 062	9 297	8 018	9 196	10 313
1 600 × 800	4 230	8 578	9 813	8 535	9 712	10 829
1 600 × 1 000	4 864	10 519	11 983	10 326	10 859	12 831
1 600 × 1 250	5 738	11 428	12 892	11 235	11 768	13 740
1 600 × 1 400	6 421	12 138	13 603	11 946	12 479	14 451
1 600 × 1 600	7 045	12 788	14 252	12 595	13 128	15 100
1 600 × 1 800	7 670	13 437	14 902	13 244	13 732	15 749
1 600 × 2 000	8 295	14 087	15 552	13 895	14 427	16 400
1 800 × 630	3 879	8 212	9 448	8 169	9 347	10 446
1 800 × 800	4 393	8 747	9 983	8 704	9 882	10 998
1 800 × 1 000	5 057	10 716	12 180	10 523	11 056	13 028
1 800 × 1 250	6 190	11 898	13 363	11 706	12 295	14 211
1 800 × 1 400	6 666	12 393	13 858	12 201	12 733	14 706
1 800 × 1 600	7 316	13 141	14 534	12 877	13 410	15 382
1 800 × 1 800	7 967	13 746	15 211	13 553	14 041	16 059
1 800 × 2 000	8 618	14 423	15 888	14 231	14 764	16 736
2 000 × 800	4 563	8 924	10 160	8 881	10 059	11 175
2 000 × 1 000	5 475	11 142	12 619	10 961	11 494	13 467
2 000 × 1 250	6 433	12 151	13 615	11 958	12 491	14 463
2 000 × 1 400	7 959	12 664	14 128	12 471	13 004	14 976
2 000 × 1 600	7 605	13 370	14 835	13 177	13 710	15 683
2 000 × 1 800	8 285	14 076	15 541	13 839	14 360	16 389
2 000 × 2 000	8 965	14 982	16 447	14 789	15 322	17 295

Typ **RKM** **500 × 400** **TPM 009/00** **.56**
 Jmenovitý rozměr
 Technické podmínky
 Provedení (dle čl. 2.5 TPM)

RKTM (TPM 012/00)

Regulační klapka těsná



RKTM – Regulační klapka těsná						
Rozměr (mm)	Provedení a cena v Kč					
	.01/.09	.45	.46	.55	.56	.57
200 × 200	995	3 143	3 761	3 121	3 710	4 268
200 × 250	1 051	3 201	3 820	3 179	3 768	4 326
200 × 315	1 193	3 346	3 965	3 324	3 913	4 471
200 × 400	1 309	3 469	4 089	3 448	4 036	4 595
200 × 500	1 487	4 295	5 029	4 199	4 465	5 452
250 × 200	1 020	3 168	3 788	3 147	3 736	4 294
250 × 250	1 078	3 229	3 849	3 208	3 797	4 355
250 × 315	1 221	3 378	3 997	3 356	3 945	4 503
250 × 400	1 343	3 505	4 125	3 483	4 072	4 631
250 × 500	1 527	4 337	5 071	4 240	4 507	5 493
250 × 630	1 728	4 546	5 280	4 450	4 716	5 702
315 × 200	1 051	3 201	3 821	3 179	3 768	4 327
315 × 250	1 114	3 266	3 885	3 244	3 833	4 391
315 × 315	1 261	3 419	4 039	3 397	3 986	4 545
315 × 400	1 388	3 552	4 171	3 530	4 119	4 677
315 × 500	1 578	4 390	5 124	4 294	4 560	5 547
315 × 630	1 789	4 609	5 343	4 513	4 779	5 766
315 × 800	2 160	4 995	5 729	4 899	5 165	6 151
400 × 200	1 094	3 245	3 865	3 224	3 812	4 371
400 × 250	1 161	3 315	3 935	3 293	3 882	4 440
400 × 315	1 314	3 474	4 094	3 453	4 042	4 600
400 × 400	1 448	3 614	4 233	3 592	4 181	4 739
400 × 500	1 647	4 461	5 195	4 365	4 631	5 618
400 × 630	1 965	4 792	5 526	4 696	4 962	5 948
400 × 800	2 254	5 093	5 827	4 997	5 263	6 249
400 × 1 000	2 624	5 478	6 212	5 381	5 648	6 634
500 × 200	1 171	3 325	3 945	3 304	3 893	4 451
500 × 250	1 244	3 401	4 021	3 380	3 968	4 527
500 × 315	1 404	3 568	4 187	3 546	4 135	4 693
500 × 400	1 538	3 707	4 327	3 686	4 275	4 833
500 × 500	1 821	4 642	5 376	4 546	4 812	5 799
500 × 630	2 057	4 888	5 622	4 792	5 058	6 045
500 × 800	2 363	5 207	5 941	5 110	5 377	6 363
500 × 1 000	2 753	5 612	6 346	5 516	5 782	6 768
500 × 1 250	3 229	8 208	8 919	7 210	7 919	9 329

RKTM – Regulační klapka těsná						
Rozměr (mm)	Provedení a cena v Kč					
	.01/09	.45	.46	.55	.56	.57
630 × 200	1 232	3 390	4 009	3 368	3 957	4 515
630 × 250	1 313	3 473	4 093	3 451	4 040	4 598
630 × 315	1 485	3 649	4 269	3 628	4 217	4 775
630 × 400	1 729	4 548	5 282	4 451	4 718	5 704
630 × 500	1 922	4 748	5 482	4 652	4 918	5 904
630 × 630	2 177	5 013	5 747	4 917	5 183	6 169
630 × 800	2 505	5 354	6 088	5 257	5 524	6 510
630 × 1 000	2 921	5 787	6 521	5 691	5 957	6 943
630 × 1 250	3 433	8 421	9 132	7 422	8 131	9 542
630 × 1 400	4 433	9 464	10 175	8 465	9 175	10 585
800 × 200	1 327	3 488	4 108	3 466	4 055	4 614
800 × 250	1 516	3 684	4 304	3 663	4 252	4 810
800 × 315	1 703	4 517	5 249	4 421	4 687	5 673
800 × 400	1 863	4 687	5 421	4 591	4 857	5 843
800 × 500	2 076	4 908	5 642	4 812	5 078	6 064
800 × 630	2 357	5 200	5 935	5 104	5 371	6 357
800 × 800	2 717	5 575	6 309	5 479	5 745	6 731
800 × 1 000	3 174	8 151	8 862	7 152	7 861	9 272
800 × 1 250	3 963	8 972	9 683	7 973	8 683	10 093
800 × 1 400	4 767	9 811	10 522	8 813	9 522	10 932
800 × 1 600	5 260	10 324	11 035	9 325	10 034	11 445
1 000 × 200	1 545	3 715	4 334	3 693	4 282	4 840
1 000 × 250	1 646	3 820	4 439	3 798	4 387	4 945
1 000 × 315	1 852	4 672	5 404	4 574	4 842	5 828
1 000 × 400	2 027	4 857	5 591	4 761	5 027	6 013
1 000 × 500	2 260	5 105	5 833	5 003	5 269	6 255
1 000 × 630	2 574	5 425	6 160	5 329	5 596	6 582
1 000 × 800	2 962	7 931	8 642	6 932	7 642	9 052
1 000 × 1 000	3 436	8 424	9 135	7 425	8 134	9 545
1 000 × 1 250	4 277	9 298	10 009	8 300	9 009	10 419
1 000 × 1 400	4 651	10 196	10 907	9 198	9 907	11 317
1 000 × 1 600	5 115	10 751	11 462	9 752	10 462	11 872
1 250 × 400	2 205	5 042	5 776	4 946	5 212	6 198
1 250 × 500	2 463	5 311	6 045	5 214	5 481	6 467
1 250 × 630	2 808	7 770	8 482	6 772	7 481	8 892
1 250 × 800	3 465	8 454	9 165	7 455	8 164	9 575
1 250 × 1 000	3 990	8 999	9 710	8 001	8 710	10 120
1 250 × 1 250	4 679	9 716	10 427	8 717	9 427	10 837
1 250 × 1 400	5 090	10 652	11 363	9 654	10 363	11 773
1 250 × 1 600	5 605	11 260	11 971	10 261	10 971	12 381
1 400 × 500	3 714	9 323	10 788	9 130	9 663	11 636

RKTM – Regulační klapka těsná						
Rozměr (mm)	Provedení a cena v Kč					
	.01/.09	.45	.46	.55	.56	.57
1 400 × 630	4 460	10 099	11 563	9 906	10 439	12 411
1 400 × 800	5 131	10 797	12 261	10 604	11 137	13 109
1 400 × 1 000	5 932	11 630	13 094	11 437	11 970	13 942
1 400 × 1 250	6 958	16 899	18 317	14 902	16 320	19 141
1 400 × 1 400	7 597	17 564	18 982	15 567	16 985	19 806
1 400 × 1 600	8 697	18 708	20 126	16 710	18 129	20 950
1 600 × 630	4 648	10 294	11 759	10 102	10 634	12 607
1 600 × 800	5 352	11 027	12 491	10 834	11 367	13 339
1 600 × 1 000	6 194	16 104	17 523	14 107	15 525	18 346
1 600 × 1 250	7 275	17 229	18 648	15 232	16 650	19 471
1 600 × 1 400	8 252	18 245	19 664	16 248	17 667	20 488
1 600 × 1 600	9 085	19 111	20 529	17 114	18 532	21 353
1 800 × 630	4 837	10 491	11 956	10 299	10 831	12 804
1 800 × 800	5 574	15 460	16 879	15 460	14 881	17 702
1 800 × 1 000	6 457	16 378	17 796	14 381	15 799	18 620
1 800 × 1 250	7 902	17 881	19 300	15 884	17 303	20 124
1 800 × 1 400	8 601	18 608	20 026	16 610	18 029	20 850
1 800 × 1 600	9 474	19 516	20 934	17 518	18 937	21 758
2 000 × 800	5 793	15 688	17 106	13 690	15 109	17 930
2 000 × 1 000	7 025	16 968	18 387	14 971	16 390	19 211
2 000 × 1 250	8 218	18 209	19 628	16 212	17 630	20 451
2 000 × 1 400	8 946	18 966	20 385	16 969	18 387	21 208
2 000 × 1 600	9 859	19 917	21 335	17 919	19 338	22 159

Typ **RKTM** **1400 × 630** **TPM 012/00** **.56**
 Jmenovitý rozměr
 Technické podmínky
 Provedení (dle čl. 2.6 TPM)

Provedení regulačních klapek	Dvojčíslí za TPM
Ruční	.01
Pro osazení servopohonu	.09
Servo - polohová regulace 230 V	.45
Servo - polohová regulace 230 V + signalizace polohy	.46
Servo - polohová regulace 24 V	.55
Servo - polohová regulace 24 V + signalizace polohy	.56
Servo-plynulá regulace 24 V SR	.57

RKKM (TPM 030/03)

Regulační klapka kruhová



RKKM – Regulační klapka kruhová – provedení spiro						
Rozměr \varnothing (mm)	Provedení a cena v Kč					
	.01/.09	.45	.46	.55	.56	.57
\varnothing 80	629	2 377	2 746	2 470	2 637	2 799
\varnothing 100	639	2 388	2 757	2 480	2 647	2 809
\varnothing 110	644	2 393	2 762	2 485	2 653	2 815
\varnothing 125	651	2 399	2 768	2 492	2 659	2 821
\varnothing 140	659	2 408	2 777	2 500	2 668	2 829
\varnothing 150	664	2 412	2 781	2 505	2 672	2 834
\varnothing 160	684	2 433	2 802	2 526	2 693	2 855
\varnothing 180	698	2 447	2 816	2 539	2 707	2 868
\varnothing 200	715	2 464	2 833	2 556	2 724	2 885
\varnothing 225	738	2 487	2 856	2 579	2 747	2 909
\varnothing 250	759	2 508	2 876	2 600	2 767	2 929
\varnothing 280	783	2 532	2 901	2 624	2 792	2 954
\varnothing 300	1 022	2 771	3 140	2 863	3 031	3 193
\varnothing 310	1 034	2 782	3 151	2 875	3 042	3 204
\varnothing 315	1 052	2 801	3 170	2 893	3 060	3 222
\varnothing 355	1 097	3 295	3 420	3 252	3 819	4 562
\varnothing 400	1 257	3 455	3 580	3 412	3 979	4 722
\varnothing 450	1 362	3 559	3 684	3 516	4 083	4 827
\varnothing 500	1 581	3 779	3 904	3 736	4 303	5 046
\varnothing 560	1 673	4 215	4 948	4 119	4 386	5 372
\varnothing 630	1 833	4 375	5 107	4 278	4 545	5 531

RKKM – Regulační klapka kruhová – provedení s přírubou						
Rozměr \varnothing (mm)	Provedení a cena v Kč					
	.01/.09	.45	.46	.55	.56	.57
\varnothing 80	786	2 535	2 904	2 627	2 795	2 957
\varnothing 100	799	2 548	2 916	2 640	2 807	2 969
\varnothing 110	807	2 556	2 925	2 649	2 816	2 978

RKKM – Regulační klapka kruhová – provedení s přírubou						
Rozměr \varnothing (mm)	Provedení a cena v Kč					
	.01/09	.45	.46	.55	.56	.57
\varnothing 125	834	2 583	2 952	2 675	2 842	3 004
\varnothing 140	849	2 598	2 967	2 691	2 858	3 020
\varnothing 160	873	2 622	2 990	2 714	2 881	3 043
\varnothing 180	752	2 501	2 870	2 593	2 761	2 923
\varnothing 200	770	2 519	2 888	2 611	2 779	2 941
\varnothing 225	802	2 551	2 920	2 644	2 811	2 973
\varnothing 250	839	2 588	2 957	2 680	2 848	3 010
\varnothing 280	879	2 627	2 996	2 720	2 887	3 049
\varnothing 300	1 180	2 929	3 298	3 021	3 189	3 350
\varnothing 315	1 038	2 787	3 156	2 879	3 047	3 208
\varnothing 355	1 117	3 315	3 440	3 272	3 839	4 582
\varnothing 400	1 479	3 677	3 736	3 634	4 201	4 944
\varnothing 450	1 577	3 774	3 900	3 732	4 298	5 042
\varnothing 500	1 791	3 988	4 113	3 945	4 512	5 256
\varnothing 560	2 034	4 576	5 308	4 479	4 746	5 732
\varnothing 630	2 267	4 809	5 542	4 713	4 979	5 966

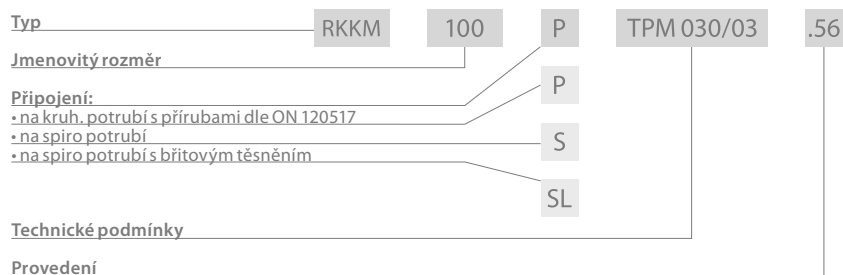

Provedení regulačních klapek	Dvojcísle za TPM
Ruční	.01
Pro osazení servopohonu	.09
Servo - polohová regulace 230 V	.45
Servo - polohová regulace 230 V + signalizace polohy	.46
Servo - polohová regulace 24 V	.55
Servo - polohová regulace 24 V + signalizace polohy	.56
Servo-plynulá regulace 24 V SR	.57

RKKTM (TPM 031/03)

Regulační klapka kruhová těsná



RKKTM – Regulační klapka kruhová – provedení spiro						
Rozměr (mm)	Provedení a cena v Kč					
	.01/.09	.45	.46	.55	.56	.57
ø 80	685	2 882	3 008	2 840	3 407	4 150
ø 100	694	2 891	3 016	2 848	3 415	4 158
ø 110	700	2 897	3 023	2 855	3 421	4 165
ø 125	706	2 904	3 029	2 861	3 428	4 171
ø 140	714	2 912	3 037	2 869	3 436	4 179
ø 150	722	2 919	3 044	2 877	3 443	4 187
ø 160	739	2 937	3 062	2 894	3 461	4 204
ø 180	753	2 950	3 075	2 907	3 474	4 218
ø 200	771	2 968	3 094	2 926	3 492	4 236
ø 225	800	2 997	3 122	2 954	3 521	4 265
ø 250	826	3 024	3 149	2 981	3 548	4 291
ø 280	852	3 049	3 175	3 007	3 573	4 317
ø 300	1 113	3 310	3 436	3 268	3 835	4 578
ø 310	1 122	3 320	3 445	3 277	3 844	4 587
ø 315	1 131	3 328	3 454	3 286	3 852	4 596
ø 355	1 196	3 738	4 470	3 641	3 908	4 894
ø 400	1 354	3 896	4 628	3 800	4 066	5 052
ø 450	1 455	3 997	4 730	3 901	4 167	5 154
ø 500	1 677	4 219	4 951	4 123	4 389	5 375
ø 560	1 771	4 313	5 045	4 216	4 483	5 469
ø 630	1 926	4 468	5 201	4 372	4 638	5 625

RKKTM – Regulační klapka kruhová – provedení s přírubou						
Rozměr (mm)	Provedení a cena v Kč					
	.01/.09	.45	.46	.55	.56	.57
ø 80	843	3 040	3 165	2 998	3 564	4 308
ø 100	853	3 051	3 176	3 008	3 575	4 318
ø 110	863	3 060	3 186	3 018	3 585	4 328

RKKTM – Regulační klapka kruhová – provedení s přírubou						
Rozměr (mm)	Provedení a cena v Kč					
	.01/.09	.45	.46	.55	.56	.57
Ø 125	890	3 087	3 212	3 044	3 611	4 355
Ø 140	905	3 102	3 228	3 060	3 626	4 370
Ø 160	928	3 125	3 250	3 082	3 649	4 393
Ø 180	807	3 004	3 129	2 962	3 528	4 272
Ø 200	826	3 024	3 149	2 981	3 548	4 291
Ø 225	864	3 061	3 187	3 019	3 585	4 329
Ø 250	907	3 104	3 229	3 062	3 628	4 372
Ø 280	947	3 145	3 270	3 102	3 669	4 412
Ø 300	1 271	3 468	3 594	3 426	3 993	4 736
Ø 315	1 117	3 314	3 440	3 272	3 838	4 582
Ø 355	1 216	3 758	4 490	3 661	3 928	4 914
Ø 400	1 576	4 118	4 850	4 022	4 288	5 274
Ø 450	1 671	4 213	4 945	4 116	4 383	5 369
Ø 500	1 887	4 429	5 161	4 332	4 599	5 585
Ø 560	2 131	4 673	5 405	4 577	4 843	5 829
Ø 630	2 361	4 903	5 635	4 807	5 073	6 059

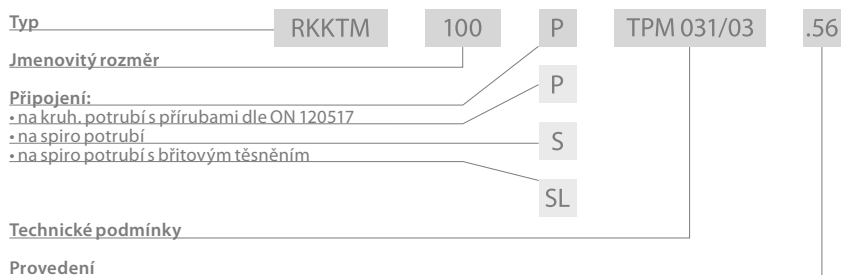

Provedení regulačních klapek	Dvojcísle za TPM
Ruční	.01
Pro osazení servopohonu	.09
Servo - polohová regulace 230 V	.45
Servo - polohová regulace 230 V + signalizace polohy	.46
Servo - polohová regulace 24 V	.55
Servo - polohová regulace 24 V + signalizace polohy	.56
Servo-plynulá regulace 24 V SR	.57

RPM (TPM 027/03)

Regulátor průtoku vzduchu



RPM – Regulátor průtoku vzduchu – provedení spiro

Rozměr (mm)	Provedení a cena v Kč			
	V	P100	P300	P600
ø 100	5 420	19 800	16 550	17 760
ø 125	5 450	19 830	16 590	17 790
ø 140	5 470	19 850	16 610	17 810
ø 160	5 500	19 880	16 640	17 840
ø 180	6 260	19 910	16 670	17 870
ø 200	6 290	19 940	16 700	17 900
ø 225	6 350	20 000	16 760	17 960
ø 250	6 400	20 050	16 810	18 010
ø 280	6 520	20 100	16 860	18 060
ø 315	6 610	20 160	16 920	18 120
ø 355	6 680	20 240	17 000	18 200
ø 400	6 800	20 350	17 100	18 300

RPM – Regulátor průtoku vzduchu – provedení s přírubou

Rozměr (mm)	Provedení a cena v Kč			
	V	P100	P300	P600
ø 100	5 550	19 990	16 680	17 760
ø 125	5 610	20 040	16 730	17 790
ø 140	5 630	20 070	16 750	17 810
ø 160	5 670	20 110	16 790	17 840
ø 180	6 440	20 160	16 850	17 870
ø 200	6 480	20 190	16 870	17 900
ø 225	6 550	20 270	16 960	17 960
ø 250	6 670	20 380	17 070	18 010
ø 280	6 740	20 460	17 140	18 060
ø 315	6 850	20 550	17 230	18 120
ø 355	6 930	20 670	17 360	18 200
ø 400	7 130	20 850	17 540	18 300

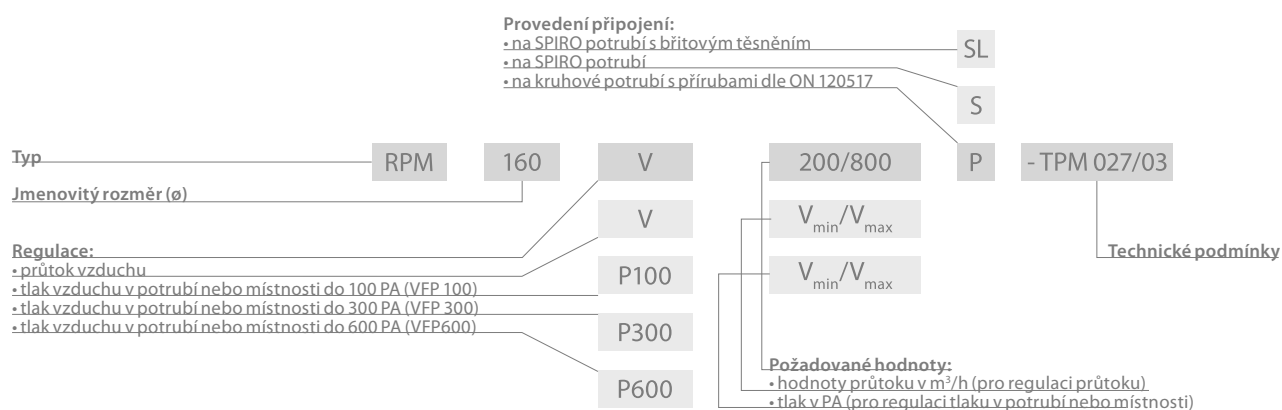

DPM (TPM 002/97)

Děrovaný panel



DPM – Děrovaný panel	
Rozměr (mm)	Provedení a cena v Kč
600	4 020

TVPM (TPM 028/03)

Talířový ventil přívodní



TVPM – Talířový ventil přívodní	
Rozměr (mm)	Cena v Kč
ø 100	250
ø 125	300
ø 160	390
ø 200	490

Typ **TVPM** **160** **TPM 028/03**
 Jmenovitý rozměr
 Technické podmínky

TVOM (TPM 028/03)

Talířový ventil odvodní

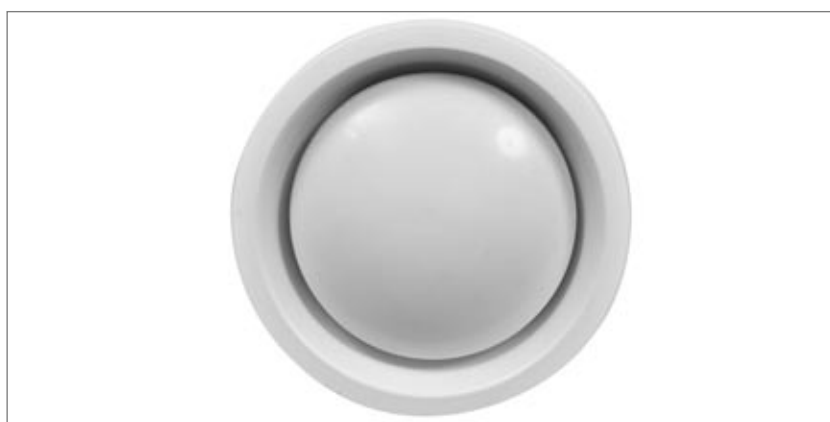

TVOM – Talířový ventil odvodní	
Rozměr (mm)	Cena v Kč
ø 100	250
ø 125	300
ø 160	390
ø 200	490

Typ **TVOM** **160** **TPM 028/03**
 Jmenovitý rozměr
 Technické podmínky

VSV (TPM 001/95)

Vyúst se štěrbinovým výtokem vzduchu



VSV – Talířový ventil	
Rozměr (mm)	Provedení a cena v Kč
600/R	1 620
600/S	1 700
600/L	1 670
600/P	1 670
1 200/R	2 780
1 200/S	2 880
1 200/L	2 840
1 200/P	2 840

Typ	VSV	600	TPM 001/95	.S	0
Jmenovitý rozměr	600				
Technické podmínky			TPM 001/95		
Provedení z hlediska použití (dle čl. 3 TPM)			.S		
Provedení z hlediska materiálu (dle čl. 3 TPM)			0		

Provedení z hlediska použití	Prvé místo za TPM
Řadové (pro možnost propojení)	.R
Samostatné	.S
Koncové – pravé	.P
Koncové – levé	.L

Provedení z hlediska materiálu	Prvé místo za TPM
Bez povrchové úpravy – pozink	.x0
S povrchovou úpravou – odstín RAL 9010 (bílá)	.x1
S povrchovou úpravou – odstín RAL 9001 (krémová)	.x2
S povrchovou úpravou – odstín RAL 9006 (hliník)	.x3

VPVM (TPM 013/01)

Velkoplošná vyúst'



VPVM – Velkoplošná vyúst'						
Provedení	Rozměr (mm)	Výška vyústí a cena v Kč				
		750	1 000	1 250	1 500	2 000
VPVM-K	400	10 440	10 960	17 070	17 780	18 920
	600	13 480	14 300	20 690	23 040	24 260
	800	19 940	20 950	26 230	29 800	32 430
	1 000	22 220	23 450	28 720	35 420	37 940
	1 200	25 600	26 700	37 250	41 850	44 710
	1 480	31 880	33 260	43 130	51 210	54 910
VPVM-K/R	400	11 400	11 910	18 030	18 710	19 880
	600	14 990	15 810	22 190	24 540	26 340
	800	21 660	22 670	27 950	31 520	34 150
	1 000	24 860	25 080	30 800	37 500	40 030
	1 200	28 050	29 150	39 670	44 220	47 170
	1 480	35 070	36 210	46 090	54 180	57 860
VPVM-S	400	9 460	9 910	12 640	14 560	15 430
	600	11 910	12 630	16 640	18 030	19 420
	800	15 070	15 930	22 310	24 760	26 540
	1 000	17 270	18 290	26 080	28 630	30 150
	1 200	19 230	20 410	28 370	31 180	33 480
	1 500	25 720	30 150	34 250	40 340	43 160
VPVM-S/R	400	10 200	10 650	13 330	15 300	16 180
	600	12 800	13 830	17 810	19 210	20 600
	800	16 370	17 240	23 610	26 060	27 840
	1 000	18 780	19 800	27 580	30 150	31 660
	1 200	20 950	22 130	30 100	32 900	35 200
	1 500	27 770	33 100	36 330	42 480	45 240
VPVM-R	800	8 700	9 160	11 760	13 840	14 740
	1 000	9 950	10 560	13 380	15 540	16 800
	1 200	12 050	12 820	18 720	20 170	21 650
	1 400	14 860	16 630	20 070	24 850	26 570
	1 600	17 600	18 830	25 650	28 440	30 380
	2 000	20 010	21 230	29 720	32 480	35 200
VPVM-R/R	800	9 440	9 910	12 500	14 590	15 480
	1 000	10 800	11 420	14 230	16 340	17 660
	1 200	13 220	13 990	19 890	21 340	22 820
	1 400	16 160	17 930	22 550	26 150	27 880
	1 600	19 170	20 130	26 350	29 740	31 630
	2 000	21 310	22 530	31 020	33 790	36 220

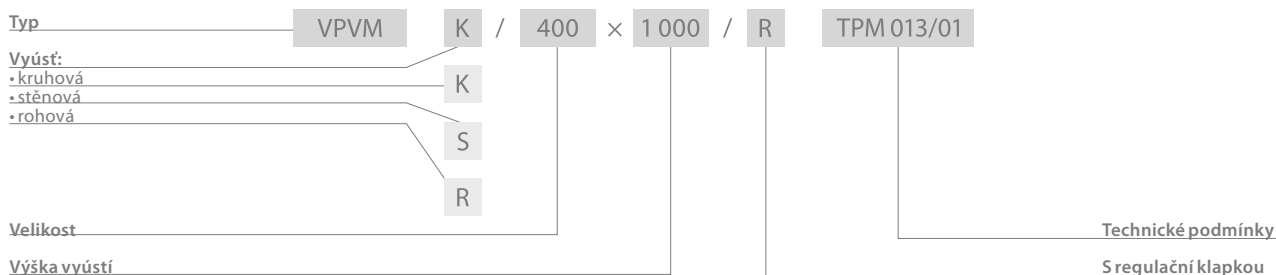

TVM (TPM 003/96)

Tlumící vložka čtyřhranná a kruhová



TLUMÍCÍ VLOŽKA ČTYŘHRANÁ	
Rozměr (mm)	Cena v Kč
125 × 100	490
125 × 125	490
160 × 125	500
160 × 160	510
200 × 160	520
200 × 200	530
250 × 160	540
250 × 200	550
250 × 250	560
315 × 160	550
315 × 200	560
315 × 250	580
315 × 315	600
400 × 200	590
400 × 250	600
400 × 315	620
400 × 400	650
500 × 250	630
500 × 315	640
500 × 400	660
500 × 500	690
630 × 315	680
630 × 400	700
630 × 500	750
630 × 630	780
710 × 400	740
710 × 500	770
710 × 630	800
710 × 710	820
800 × 400	770
800 × 500	790
800 × 630	820
800 × 710	850
800 × 800	880
900 × 500	820
900 × 630	850
900 × 710	890
900 × 800	940

TLUMÍCÍ VLOŽKA ČTYŘHRANÁ	
Rozměr (mm)	Cena v Kč
900 × 900	990
1 000 × 500	850
1 000 × 630	900
1 000 × 710	940
1 000 × 800	990
1 000 × 900	1 050
1 000 × 1 000	1 090
1 120 × 630	960
1 120 × 710	980
1 120 × 800	1 020
1 120 × 900	1 100
1 120 × 1 000	1 170
1 120 × 1 120	1 180
1 250 × 630	1 030
1 250 × 710	1 080
1 250 × 800	1 120
1 250 × 900	1 190
1 250 × 1 000	1 230
1 250 × 1 120	1 300
1 250 × 1 250	1 350
1 400 × 710	1 160
1 400 × 800	1 210
1 400 × 900	1 260
1 400 × 1 000	1 300
1 400 × 1 120	1 380
1 400 × 1 250	1 450
1 400 × 1 400	1 500
1 600 × 800	1 320
1 600 × 900	1 370
1 600 × 1 000	1 430
1 600 × 1 120	1 490
1 600 × 1 250	1 550
1 600 × 1 400	1 610
1 800 × 900	1 480
1 800 × 1 000	1 520
1 800 × 1 120	1 600
1 800 × 1 250	1 670
1 800 × 1 400	1 740

TLUMÍCÍ VLOŽKA KRUHOVÁ	
Rozměr (mm)	Cena v Kč
ø 100	260
ø 125	280
ø 140	290
ø 160	300
ø 180	310
ø 200	320
ø 225	330
ø 250	380
ø 280	400
ø 315	430
ø 355	450
ø 400	520
ø 450	550
ø 500	660
ø 560	780
ø 630	860
ø 710	960
ø 800	1 130

Typ Jmenovitý rozměr (A × B nebo ø) Technické podmínky

KMM (TPM 002/96)

Krycí mřížka čtyřhranná a kruhová



Rozměr (mm)	Provedení a cena v Kč			
	.20	.21	.30	.31
125 x 125	254	254	451	451
160 x 125	258	258	456	456
160 x 160	262	262	463	463
200 x 125	262	262	463	463
200 x 160	267	267	469	469
200 x 200	272	272	477	477
250 x 125	267	267	469	469
250 x 160	273	273	478	478
250 x 200	280	280	488	488
250 x 250	288	288	499	499
315 x 125	274	274	480	480
315 x 160	281	281	490	490
315 x 200	289	289	501	501
315 x 250	299	299	515	515
315 x 315	312	312	534	534
400 x 160	291	291	504	504
400 x 200	301	301	518	518
400 x 250	314	314	536	536
400 x 315	330	330	559	559
400 x 400	351	351	588	588
500 x 200	315	315	538	538
500 x 250	330	330	559	559
500 x 315	350	350	587	587
500 x 400	376	376	623	623
500 x 500	406	406	665	665
630 x 250	352	352	590	590
630 x 315	377	377	640	640
630 x 400	408	408	720	720
630 x 500	446	446	730	730
630 x 630	494	494	788	788
800 x 315	412	412	730	730
800 x 400	451	451	750	750
800 x 500	497	497	810	810
800 x 630	558	558	877	877
800 x 800	794	794	1 270	1 270
1 000 x 400	658	658	1 081	1 081
1 000 x 500	715	715	1 160	1 160
1 000 x 630	789	789	1 263	1 263
1 000 x 800	886	886	1 398	1 398
1 250 x 500	791	791	1 266	1 266
1 250 x 630	883	883	1 394	1 394
1 250 x 800	1 003	1 003	1 561	1 561

KMM – Krycí mřížka čtyřhranná a kruhová				
Rozměr (mm)	Provedení a cena v Kč			
	.20	.21	.30	.31
Ø 100	205	205	364	364
Ø 160	231	231	406	406
Ø 200	250	250	437	437
Ø 250	276	276	478	478
Ø 280	292	292	504	504
Ø 315	312	312	535	535
Ø 355	337	337	575	575
Ø 400	365	365	619	619
Ø 450	441	441	719	719
Ø 500	501	501	849	849
Ø 560	554	554	923	923
Ø 630	620	620	1 024	1 024
Ø 710	700	700	1 147	1 147
Ø 800	797	797	1 295	1 295

Provedení z hlediska umístění		
Provedení	Umístění	Prvé místo za TPM
mřížka s přírubou	na boční stěny a do potrubí	.2
mřížka s přírubou	na volné konce potrubí	.2
mřížka s přírubou, rámem a příchýtkami	pro osazení do zdi	.3

Provedení z hlediska povrchové ochrany	
Provedení	Druhé místo za TPM
povrchová úprava nátěrem – základní nátěr	.x0
povrchová úprava nátěrem – odstín RAL 9010 (bílá)	.x1
povrchová úprava nátěrem – odstín RAL 9001 (krémová)	.x2
povrchová úprava nátěrem – odstín RAL 9006 (hliník)	.x3
Atypický odstín – nutné projednat s výrobcem	.x9

Typ	KMM	400 × 400 (Ø 450)	.2	3	TPM 002/96
Jmenovitý rozměr					
Provedení z hlediska umístění • dle čl. 2 TPM					
Provedení z hlediska povrchové ochrany • dle čl. 2 TPM					
Technické podmínky					

SMM (TPM 014/01)

Stěnová mřížka

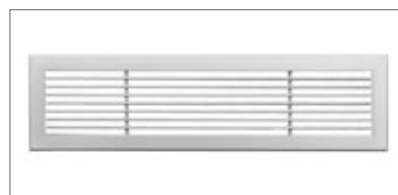

SMM – Stěnová mřížka						
Rozměr (mm)	Provedení a cena v Kč					
	12,5	12,5/UR1	12,5/UR2	20	20/UR1	20/UR2
200×50	380	380	390	360	360	370
200×100	430	430	440	390	390	400
200×150	490	490	500	430	430	440
200×200	540	540	550	470	470	480
200×250	600	600	610	510	510	520
200×300	650	650	660	550	550	560
200×350	710	710	720	590	590	600
200×400	770	770	780	630	630	640
300×50	410	410	420	390	390	400
300×100	470	470	480	430	430	440
300×150	540	540	550	480	480	490
300×200	610	610	620	520	520	530
300×250	670	670	680	570	570	580
300×300	740	740	750	610	610	620
300×350	810	810	820	660	660	670
300×400	880	880	890	700	700	710
400×50	450	450	460	420	420	430
400×100	520	520	530	460	460	470
400×150	600	600	610	520	520	530
400×200	670	670	680	570	570	580
400×250	750	750	760	630	630	640
400×300	830	830	840	670	670	680
400×350	860	860	870	690	690	700
400×400	980	980	990	780	780	790
500×50	480	480	490	460	460	470
500×100	570	570	580	500	500	510
500×150	660	660	670	570	570	580
500×200	750	750	760	620	620	630
500×250	830	830	840	690	690	700
500×300	920	920	930	740	740	750
500×350	1 010	1 010	1 020	810	810	820
500×400	1 090	1 090	1 100	860	860	870
600×50	540	540	550	520	520	530
600×100	640	640	650	570	570	580
600×150	750	750	760	650	650	660
600×200	860	860	870	710	710	720
600×250	960	960	970	790	790	800
600×300	1 060	1 060	1 070	860	860	870
600×350	1 150	1 150	1 160	930	930	940
600×400	1 270	1 270	1 280	980	980	990
700×50	580	580	590	550	550	560
700×100	690	690	700	610	610	620
700×150	800	800	810	690	690	700
700×200	920	920	930	760	760	770
700×250	1 040	1 040	1 050	850	850	860
700×300	1 140	1 140	1 150	920	920	930

SMM – Stěnová mřížka						
Rozměr (mm)	Provedení a cena v Kč					
	12,5	12,5 UR1	12,5/UR2	20	20/UR1	20/UR2
700×350	1 260	1 260	1 270	1 000	1 000	1 010
700×400	1 370	1 370	1 380	1 070	1 070	1 080
800×50	650	650	660	620	620	630
800×100	770	770	780	670	670	680
800×150	900	900	910	780	780	790
800×200	1 040	1 040	1 050	850	850	860
800×250	1 170	1 170	1 180	950	950	960
800×300	1 290	1 290	1 300	1 030	1 030	1 040
800×350	1 430	1 430	1 440	1 120	1 120	1 130
800×400	1 560	1 560	1 570	1 200	1 200	1 210
900×50	680	680	690	650	650	660
900×100	820	820	830	720	720	730
900×150	960	960	970	820	820	830
900×200	1 100	1 100	1 110	900	900	910
900×250	1 240	1 240	1 250	1 010	1 010	1 020
900×300	1 380	1 380	1 390	1 090	1 090	1 100
900×350	1 530	1 530	1 540	1 200	1 200	1 210
900×400	1 660	1 660	1 670	1 270	1 270	1 280
1 000×50	730	730	740	700	700	710
1 000×100	880	880	890	770	770	780
1 000×150	1 040	1 040	1 050	890	890	900
1 000×200	1 190	1 190	1 200	970	970	980
1 000×250	1 350	1 350	1 360	1 090	1 090	1 100
1 000×300	1 490	1 490	1 500	1 180	1 180	1 190
1 000×350	1 660	1 660	1 670	1 290	1 290	1 300
1 000×400	1 810	1 810	1 820	1 380	1 380	1 390
225×75	400	400	410	380	380	390
325×75	450	450	460	420	420	430
425×75	480	480	490	450	450	460
525×75	530	530	540	490	490	500
625×75	600	600	610	550	550	560
725×75	640	640	650	590	590	600
825×75	710	710	720	650	650	660
1 025×75	810	810	820	740	740	750
1 225×75	910	910	920	830	830	840
225×125	460	460	470	410	410	420
325×125	510	510	520	450	450	460
425×125	560	560	570	490	490	500
525×125	620	620	630	540	540	550
625×125	700	700	710	610	610	620
725×125	750	750	760	650	650	660
825×125	840	840	850	730	730	740
1 025×125	960	960	970	820	820	830
1 225×125	1 080	1 080	1 090	930	930	940
225×225	580	580	590	490	490	500
325×225	650	650	660	540	540	550
425×225	720	720	730	600	600	610
525×225	800	800	810	650	650	660
625×225	900	900	910	740	740	750
725×225	970	970	980	790	790	800
825×225	1 100	1 100	1 110	890	890	900
1 025×225	1 260	1 260	1 270	1 010	1 010	1 020
1 225×225	1 460	1 460	1 470	1 150	1 150	1 160
225×325	700	700	710	570	570	580

SMM – Stěnová mřížka						
Rozměr (mm)	Provedení a cena v Kč					
	12,5	12,5/UR1	12,5/UR2	20	20/UR1	20/UR2
325 × 325	790	790	800	640	640	650
425 × 325	880	880	890	700	700	710
525 × 325	980	980	990	770	770	780
625 × 325	1 130	1 130	1 140	880	880	890
725 × 325	1 220	1 220	1 230	940	940	950
825 × 325	1 370	1 370	1 380	1 060	1 060	1 070
1 025 × 325	1 590	1 590	1 600	1 220	1 220	1 230
1 225 × 325	1 850	1 850	1 860	1 390	1 390	1 400

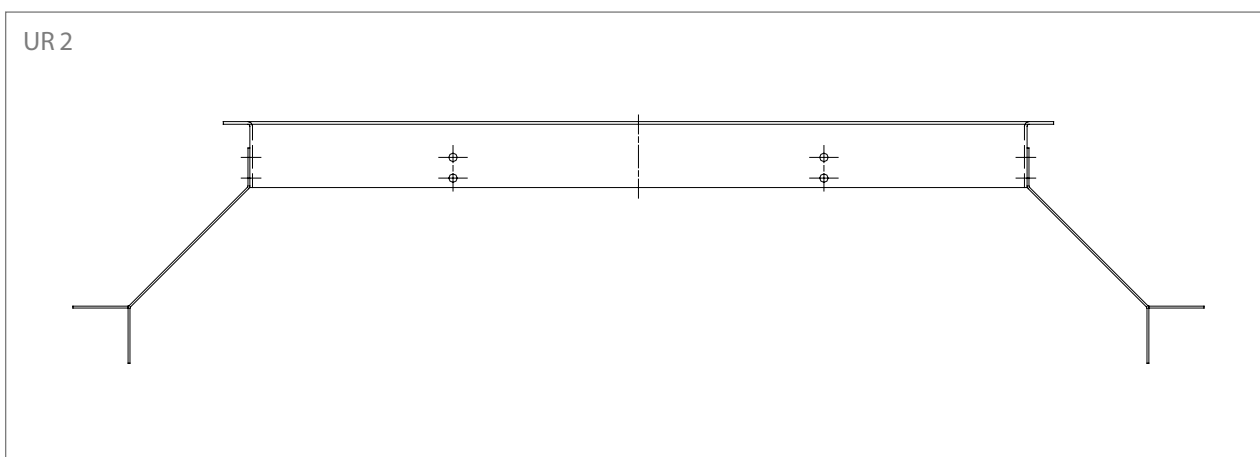
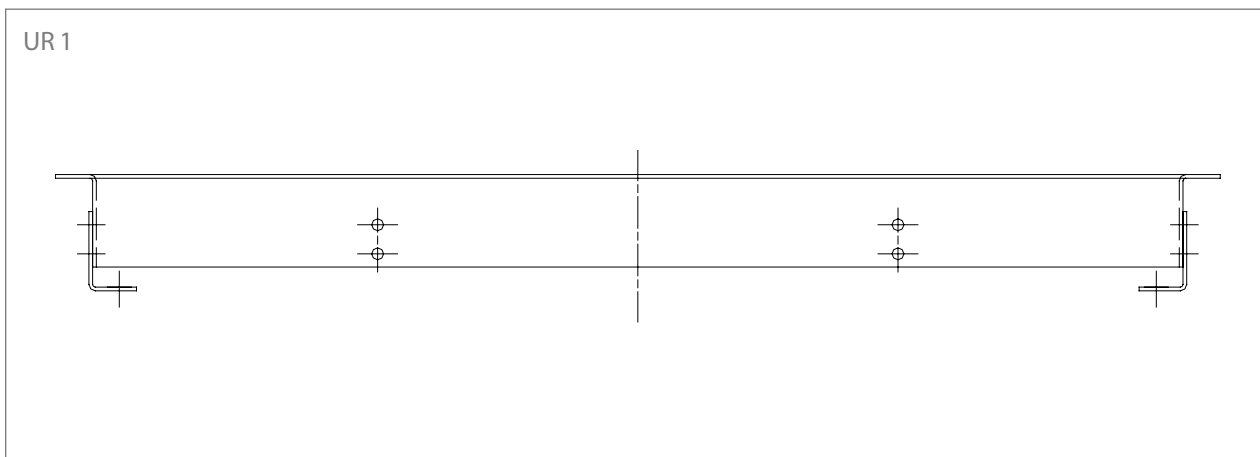
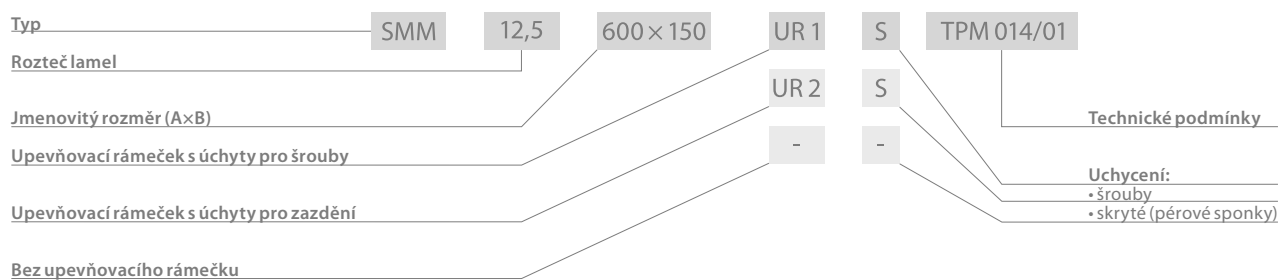

VNM (TPM 015/01)

Vyústka nastavitelná

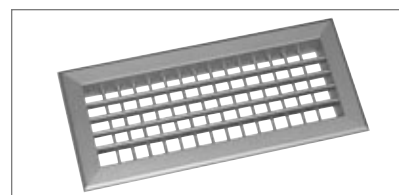

VNM – vyústka nastavitelná										
Rozměr (mm)	Provedení a cena v Kč									
	Jednořadé					Dvouřadé				
	1	1/UR	1/R1	1/R2	1/R3	2	2/UR	2/R1	2/R2	2/R3
200 × 75	360	360	530	670	600	420	420	590	730	630
200 × 80	360	360	530	670	600	420	420	590	730	630
200 × 100	370	370	540	690	620	430	430	590	750	650
200 × 120	380	380	550	700	630	450	450	600	770	680
200 × 125	380	380	550	710	640	450	450	620	770	680
200 × 140	400	400	560	720	670	470	470	640	790	700
200 × 200	430	430	610	770	710	510	510	690	850	770
200 × 220	450	450	620	780	730	530	530	710	870	800
200 × 225	450	450	620	790	740	530	530	710	870	800
200 × 280	480	480	660	830	790	580	580	790	930	860
200 × 320	530	530	720	890	860	630	630	830	1 000	940
200 × 325	530	530	720	900	860	680	680	830	1 000	940
200 × 425	590	590	790	970	950	720	720	920	1 100	1 060
200 × 525	660	660	870	1 060	1 060	810	810	1 020	1 210	1 180
220 × 75	370	370	550	690	610	430	430	600	750	640
220 × 80	370	370	540	700	610	430	430	600	760	650
220 × 100	380	380	540	710	630	440	440	610	780	670
220 × 120	390	390	560	730	650	460	460	630	800	700
220 × 125	390	390	560	730	660	460	460	630	800	700
220 × 140	410	410	570	750	670	480	480	650	820	720
220 × 200	440	440	620	800	740	520	520	710	880	800
220 × 220	460	460	630	820	760	550	550	730	910	830
220 × 225	460	460	630	820	760	550	550	730	910	830
220 × 280	500	500	680	870	820	600	600	780	980	900
220 × 320	540	540	730	930	890	660	660	850	1 040	980
220 × 325	540	540	730	930	890	660	660	850	1 050	990
220 × 425	610	610	810	1 020	990	750	750	950	1 160	1 110
220 × 525	680	680	890	1 110	1 110	850	850	1 050	1 270	1 250
225 × 75	370	370	540	700	620	430	430	600	760	740
225 × 80	370	370	540	700	620	430	430	600	760	650
225 × 100	380	380	550	720	640	440	440	610	780	680
225 × 120	390	390	560	730	660	460	460	630	800	700
225 × 125	390	390	560	740	660	460	460	630	810	710
225 × 140	410	410	570	750	680	480	480	650	830	730
225 × 200	440	440	620	800	740	530	530	710	890	800

VNM – vyústka nastavitelná										
Rozměr (mm)	Provedení a cena v Kč									
	Jednořadé					Dvouřadé				
	1	1/UR	1/R1	1/R2	1/R3	2	2/UR	2/R1	2/R2	2/R3
225 × 220	460	460	630	820	760	550	550	730	910	830
225 × 225	460	460	640	830	770	550	550	730	920	840
225 × 280	500	500	680	880	830	600	600	790	980	910
225 × 320	550	550	740	940	900	660	660	850	1 050	990
225 × 325	550	550	740	940	900	660	660	860	1 060	990
225 × 425	610	610	810	1 020	1 000	750	750	960	1 160	1 120
225 × 525	690	690	890	1 120	1 120	850	850	1 060	1 280	1 260
280 × 75	390	390	610	770	660	460	460	680	840	700
280 × 80	390	390	610	780	660	460	460	680	850	700
280 × 100	400	400	610	790	680	480	480	690	870	730
280 × 120	420	420	630	810	700	500	500	710	890	760
280 × 125	420	420	630	820	710	500	500	720	900	770
280 × 140	430	430	650	840	730	520	520	740	920	790
280 × 200	470	470	700	890	800	570	570	810	1 000	880
280 × 220	490	490	710	920	820	600	600	830	1 030	910
280 × 225	490	490	720	920	830	600	600	830	1 030	920
280 × 280	530	530	760	980	890	660	660	900	1 110	1 000
280 × 320	580	580	830	1 040	970	730	730	970	1 190	1 090
280 × 325	580	580	830	1 050	980	730	730	980	1 190	1 100
280 × 425	660	660	910	1 150	1 100	830	830	1 090	1 320	1 250
280 × 525	740	740	1 000	1 250	1 240	940	940	1 210	1 460	1 420
320 × 75	400	400	630	810	690	470	470	700	880	740
320 × 80	400	400	630	810	690	480	480	710	890	740
320 × 100	410	410	640	830	710	500	500	730	910	770
320 × 120	430	430	650	850	720	520	520	750	920	790
320 × 125	430	430	650	850	740	520	520	750	950	810
320 × 140	440	440	670	880	770	540	540	770	970	840
320 × 200	480	480	730	940	850	600	600	850	1 060	940
320 × 220	500	500	740	960	870	630	630	870	1 090	980
320 × 225	500	500	750	970	880	630	630	880	1 100	980
320 × 280	550	550	800	1 030	950	700	700	950	1 180	1 080
320 × 320	600	600	860	1 100	1 040	770	770	1 030	1 260	1 180
320 × 325	610	610	870	1 110	1 050	770	770	1 030	1 270	1 190
320 × 425	680	680	960	1 210	1 180	880	880	1 160	1 410	1 360
320 × 525	770	770	1 050	1 320	1 280	1 010	1 010	1 290	1 560	1 490
325 × 75	400	400	630	810	690	470	470	710	880	740
325 × 80	400	400	630	810	690	480	480	710	890	740
325 × 100	410	410	630	830	690	500	500	720	920	770
325 × 120	430	430	650	850	740	520	520	750	940	810
325 × 125	430	430	650	860	740	520	520	750	950	810
325 × 140	440	440	670	880	770	540	540	770	980	840

VNM – vyústka nastavitelná										
Rozměr (mm)	Provedení a cena v Kč									
	Jednořadé					Dvouřadé				
	1	1/UR	1/R1	1/R2	1/R3	2	2/UR	2/R1	2/R2	2/R3
325 × 200	480	480	730	940	850	600	600	850	1 060	950
325 × 220	500	500	740	960	880	630	630	870	1 090	980
325 × 225	510	510	750	970	880	640	640	880	1 100	990
325 × 280	550	550	800	1 030	960	700	700	950	1 180	1 080
325 × 320	600	600	860	1 100	1 040	770	770	1 030	1 270	1 180
325 × 325	610	610	870	1 110	1 050	770	770	1 040	1 270	1 190
325 × 425	680	680	960	1 210	1 190	890	890	1 160	1 420	1 370
325 × 525	770	770	1 060	1 330	1 340	1 010	1 010	1 300	1 570	1 550
400 × 75	420	420	700	920	750	510	510	820	1 040	840
400 × 80	430	430	700	930	750	550	550	820	1 050	850
400 × 100	440	440	710	950	780	570	570	840	1 080	880
400 × 120	460	460	730	970	810	600	600	870	1 110	930
400 × 125	460	460	730	980	820	600	600	880	1 120	940
400 × 140	470	470	750	1 000	840	620	620	900	1 150	970
400 × 200	520	520	820	1 080	940	700	700	1 000	1 250	1 100
400 × 220	540	540	840	1 100	980	730	730	1 030	1 290	1 140
400 × 225	540	540	840	1 110	980	730	730	1 030	1 300	1 150
400 × 280	600	600	900	1 180	1 070	810	810	1 120	1 400	1 260
400 × 320	650	650	970	1 260	1 160	900	900	1 220	1 510	1 390
400 × 325	660	660	970	1 270	1 170	900	900	1 230	1 520	1 400
400 × 425	740	740	1 080	1 390	1 330	1 040	1 040	1 380	1 690	1 600
400 × 525	840	840	1 190	1 490	1 510	1 180	1 180	1 540	1 830	1 820
420 × 75	430	430	710	900	760	560	560	840	1 030	860
420 × 80	430	430	710	910	760	560	560	840	1 040	860
420 × 100	450	450	730	940	800	580	580	860	1 070	910
420 × 120	460	460	740	960	830	610	610	890	1 110	950
420 × 125	470	470	750	970	840	610	610	900	1 110	960
420 × 140	480	480	760	990	860	640	640	980	1 150	990
420 × 200	530	530	830	1 070	970	710	710	1 020	1 250	1 130
420 × 220	550	550	850	1 100	1 000	750	750	1 050	1 290	1 170
420 × 225	560	560	850	1 100	1 010	750	750	1 050	1 300	1 180
420 × 280	610	610	920	1 180	1 100	830	830	1 140	1 400	1 300
420 × 320	670	670	990	1 260	1 200	920	920	1 250	1 510	1 430
420 × 325	670	670	990	1 270	1 200	930	930	1 250	1 520	1 440
420 × 425	760	760	1 100	1 390	1 370	1 070	1 070	1 410	1 700	1 650
420 × 525	860	860	1 210	1 520	1 550	1 220	1 220	1 570	1 880	1 880
425 × 75	430	430	720	940	760	560	560	850	1 060	860
425 × 80	440	440	720	940	770	560	560	850	1 070	870
425 × 100	450	450	730	960	800	580	580	870	1 100	910
425 × 120	470	470	760	990	830	610	610	900	1 130	950
425 × 125	470	470	760	1 000	840	610	610	910	1 140	960

VNM – vyústka nastavitelná										
Rozměr (mm)	Provedení a cena v Kč									
	Jednořadé					Dvouřadé				
	1	1/UR	1/R1	1/R2	1/R3	2	2/UR	2/R1	2/R2	2/R3
425 × 140	490	490	780	1 020	870	640	640	940	1 180	1 000
425 × 200	530	530	850	1 100	970	720	720	1 030	1 280	1 130
425 × 220	560	560	870	1 120	1 000	750	750	1 060	1 320	1 170
425 × 225	560	560	870	1 130	1 010	750	750	1 070	1 330	1 180
425 × 280	610	610	930	1 210	1 110	840	840	1 160	1 430	1 310
425 × 320	670	670	1 010	1 290	1 200	930	930	1 270	1 540	1 430
425 × 325	670	670	1 010	1 300	1 210	930	930	1 270	1 550	1 430
425 × 425	760	760	1 110	1 420	1 380	1 070	1 070	1 430	1 730	1 660
425 × 525	860	860	1 240	1 550	1 560	1 220	1 220	1 600	1 910	1 890
520 × 75	470	470	810	1 090	840	610	610	960	1 230	960
520 × 80	470	470	810	1 100	850	610	610	960	1 240	970
520 × 100	490	490	830	1 130	880	640	640	990	1 280	1 020
520 × 120	510	510	850	1 160	920	680	680	1 020	1 330	1 070
520 × 125	510	510	850	1 170	930	680	680	1 030	1 340	1 080
520 × 140	530	530	880	1 190	970	680	770	1 060	1 380	1 120
520 × 200	590	590	950	1 280	1 090	800	800	1 180	1 500	1 280
520 × 220	610	610	980	1 320	1 130	840	840	1 210	1 550	1 340
520 × 225	610	610	980	1 330	1 140	850	850	1 220	1 560	1 350
520 × 280	670	670	1 050	1 420	1 250	940	940	1 330	1 680	1 490
520 × 320	740	740	1 140	1 510	1 350	1 040	1 040	1 450	1 810	1 640
520 × 325	740	740	1 140	1 520	1 360	1 050	1 050	1 450	1 830	1 650
520 × 425	840	840	1 270	1 670	1 560	1 210	1 210	1 650	2 040	1 910
520 × 525	950	950	1 400	1 820	1 620	1 390	1 390	1 840	2 260	2 030
525 × 75	470	470	810	1 100	840	610	610	960	1 240	960
525 × 80	470	470	810	1 100	850	620	620	960	1 250	970
525 × 100	490	490	830	1 130	890	650	650	990	1 290	1 020
525 × 120	510	510	850	1 160	920	680	680	1 030	1 330	1 070
525 × 125	510	510	860	1 170	930	680	680	1 030	1 340	1 080
525 × 140	530	530	880	1 200	970	710	710	1 060	1 380	1 120
525 × 200	590	590	950	1 290	1 090	810	810	1 180	1 510	1 280
525 × 220	610	610	980	1 320	1 130	850	850	1 220	1 550	1 340
525 × 225	610	610	980	1 330	1 140	850	850	1 220	1 570	1 350
525 × 280	680	680	1 060	1 420	1 250	940	940	1 330	1 690	1 490
525 × 320	740	740	1 140	1 510	1 350	1 050	1 050	1 450	1 820	1 630
525 × 325	740	740	1 140	1 520	1 360	1 050	1 050	1 460	1 830	1 650
525 × 425	850	850	1 270	1 670	1 560	1 220	1 220	1 650	2 030	1 910
525 × 525	960	960	1 400	1 830	1 780	1 390	1 390	1 840	2 260	2 190
560 × 75	480	480	850	1 130	870	630	630	1 000	1 280	1 000
560 × 80	480	480	850	1 130	880	640	640	1 000	1 280	1 000
560 × 100	500	500	860	1 160	920	670	670	1 030	1 330	1 060
560 × 120	520	520	890	1 200	960	700	700	1 070	1 370	1 110

VNM – vyústka nastavitelná										
Rozměr (mm)	Provedení a cena v Kč									
	Jednořadé					Dvouřadé				
	1	1/UR	1/R1	1/R2	1/R3	2	2/UR	2/R1	2/R2	2/R3
560 × 125	520	520	900	1 200	960	700	700	1 080	1 390	1 120
560 × 140	550	550	920	1 230	1 000	740	740	1 120	1 430	1 170
560 × 200	610	610	1 000	1 330	1 130	840	840	1 240	1 560	1 340
560 × 220	630	630	1 030	1 370	1 180	880	880	1 280	1 610	1 400
560 × 225	630	630	1 030	1 380	1 180	880	880	1 280	1 620	1 410
560 × 280	700	700	1 110	1 470	1 200	990	990	1 400	1 760	1 570
560 × 320	770	770	1 200	1 570	1 410	1 090	1 090	1 530	1 890	1 710
560 × 325	770	770	1 200	1 580	1 420	1 100	1 100	1 540	1 910	1 730
560 × 425	880	880	1 340	1 740	1 640	1 270	1 270	1 740	2 130	2 010
560 × 525	1 000	1 000	1 480	1 900	1 860	1 460	1 460	1 950	2 370	2 300
620 × 75	510	510	910	1 180	920	700	700	1 100	1 370	1 080
620 × 80	510	510	910	1 190	920	700	700	1 110	1 380	1 090
620 × 100	530	530	920	1 220	970	740	740	1 130	1 430	1 150
620 × 120	550	550	950	1 250	1 010	770	770	1 170	1 480	1 210
620 × 125	550	550	950	1 260	1 020	780	780	1 190	1 490	1 450
620 × 140	570	570	980	1 300	1 060	810	810	1 220	1 530	1 480
620 × 200	640	640	1 070	1 400	1 200	920	920	1 360	1 680	1 460
620 × 220	670	670	1 100	1 440	1 250	970	970	1 400	1 740	1 520
620 × 225	670	670	1 100	1 450	1 260	970	970	1 410	1 750	1 540
620 × 280	740	740	1 190	1 550	1 390	1 080	1 080	1 530	1 900	1 710
620 × 320	810	810	1 280	1 650	1 510	1 190	1 190	1 670	2 040	1 870
620 × 325	810	810	1 280	1 670	1 520	1 200	1 200	1 680	2 060	1 880
620 × 425	930	930	1 430	1 840	1 770	1 390	1 390	1 900	2 300	2 190
620 × 525	1 050	1 050	1 580	2 020	1 990	1 600	1 600	2 130	2 560	2 510
625 × 75	510	510	910	1 190	920	700	700	1 100	1 370	1 090
625 × 80	510	510	910	1 190	930	700	700	1 110	1 390	1 100
625 × 100	530	530	920	1 220	970	740	740	1 140	1 430	1 150
625 × 120	550	550	950	1 260	1 020	780	780	1 180	1 480	1 220
625 × 125	550	550	960	1 270	1 020	780	780	1 190	1 500	1 230
625 × 140	580	580	980	1 300	1 070	820	820	1 230	1 540	1 270
625 × 200	640	640	1 070	1 400	1 210	930	930	1 360	1 690	1 470
625 × 220	670	670	1 100	1 440	1 250	970	970	1 400	1 740	1 530
625 × 225	670	670	1 100	1 460	1 260	970	970	1 410	1 760	1 540
625 × 280	740	740	1 190	1 560	1 400	1 090	1 090	1 540	1 900	1 720
625 × 320	810	810	1 280	1 660	1 520	1 200	1 200	1 670	2 050	1 880
625 × 325	810	810	1 280	1 670	1 520	1 200	1 200	1 680	2 070	1 890
625 × 425	930	930	1 430	1 840	1 760	1 310	1 310	1 910	2 310	2 200
625 × 525	1 060	1 060	1 580	2 030	2 000	1 600	1 600	2 130	2 570	2 520
720 × 75	540	540	1 000	1 350	1 000	740	740	1 140	1 560	1 180
720 × 80	540	540	1 000	1 360	1 000	750	750	1 210	1 570	1 180
720 × 100	560	560	1 000	1 400	1 050	790	790	1 240	1 620	1 260

VNM – vyústka nastavitelná										
Rozměr (mm)	Provedení a cena v Kč									
	Jednořadé					Dvouřadé				
	1	1/UR	1/R1	1/R2	1/R3	2	2/UR	2/R1	2/R2	2/R3
720 × 120	590	590	1 040	1 440	1 100	830	830	1 290	1 680	1 320
720 × 125	590	590	1 050	1 450	1 110	840	840	1 300	1 700	1 340
720 × 140	620	620	1 080	1 480	1 160	880	880	1 340	1 750	1 400
720 × 200	690	690	1 170	1 600	1 320	1 000	1 000	1 490	1 910	1 610
720 × 220	720	720	1 210	1 640	1 370	1 050	1 050	1 540	1 980	1 680
720 × 225	720	720	1 210	1 660	1 380	1 060	1 060	1 550	1 990	1 690
720 × 280	800	800	1 310	1 770	1 530	1 180	1 180	1 700	2 160	1 890
720 × 320	870	870	1 410	1 880	1 660	1 310	1 310	1 850	2 320	2 070
720 × 325	870	870	1 410	1 900	1 670	1 310	1 310	1 850	2 560	2 090
720 × 425	1 010	1 010	1 580	2 090	1 930	1 530	1 530	2 110	2 620	2 440
720 × 525	1 140	1 140	1 740	2 290	2 210	1 760	1 760	2 360	2 910	2 800
725 × 75	540	540	1 000	1 350	1 000	750	750	1 210	1 560	1 180
725 × 80	540	540	1 000	1 360	1 000	750	750	1 210	1 570	1 190
725 × 100	560	560	1 010	1 400	1 050	790	790	1 240	1 630	1 260
725 × 120	590	590	1 040	1 440	1 110	840	840	1 290	1 680	1 330
725 × 125	590	590	1 050	1 450	1 120	840	840	1 300	1 700	1 340
725 × 140	620	620	1 080	1 490	1 160	880	880	1 340	1 750	1 400
725 × 200	690	690	1 180	1 600	1 320	1 010	1 010	1 500	1 920	1 420
725 × 220	720	720	1 210	1 650	1 380	1 060	1 060	1 550	1 980	1 690
725 × 225	720	720	1 210	1 660	1 390	1 060	1 060	1 560	2 000	1 700
725 × 280	800	800	1 310	1 780	1 540	1 190	1 190	1 700	2 160	1 900
725 × 320	880	880	1 410	1 890	1 670	1 310	1 310	1 850	2 320	2 080
725 × 325	880	880	1 410	1 900	1 680	1 320	1 320	1 860	2 340	2 090
725 × 425	1 010	1 010	1 580	2 090	1 940	1 540	1 540	2 110	2 620	2 450
725 × 525	1 150	1 150	1 750	2 300	2 220	1 760	1 760	2 370	2 910	2 810
820 × 75	690	690	1 190	1 600	1 160	900	900	1 410	1 810	1 380
820 × 80	690	690	1 190	1 600	1 160	900	900	1 410	1 820	1 380
820 × 100	700	700	1 200	1 640	1 240	940	940	1 450	1 880	1 480
820 × 120	740	740	1 240	1 690	1 280	990	990	1 510	1 950	1 540
820 × 125	740	740	1 250	1 700	1 290	1 000	1 000	1 520	1 970	1 560
820 × 140	770	770	1 280	1 740	1 340	1 050	1 050	1 570	2 030	1 600
820 × 200	860	860	1 400	1 890	1 530	1 200	1 200	1 750	2 230	1 840
820 × 220	900	900	1 440	1 940	1 600	1 260	1 260	1 810	2 300	1 920
820 × 225	900	900	1 450	1 960	1 610	1 260	1 260	1 820	2 320	1 930
820 × 280	1 000	1 000	1 560	2 100	1 780	1 420	1 420	1 990	2 520	2 160
820 × 320	1 110	1 110	1 700	2 250	1 930	1 560	1 560	2 160	2 700	2 330
820 × 325	1 110	1 110	1 710	2 270	1 940	1 560	1 560	2 170	2 720	2 340
820 × 425	1 270	1 270	1 910	2 500	2 290	1 830	1 830	2 470	3 060	2 770
820 × 525	1 440	1 440	2 110	2 750	2 610	2 100	2 100	2 770	3 400	3 190
825 × 75	690	690	1 190	1 600	1 160	900	900	1 420	1 820	1 350
825 × 80	690	690	1 190	1 600	1 160	900	900	1 420	1 820	1 360

VNM – vyústka nastavitelná										
Rozměr (mm)	Provedení a cena v Kč									
	Jednořadé					Dvouřadé				
	1	1/UR	1/R1	1/R2	1/R3	2	2/UR	2/R1	2/R2	2/R3
825 × 100	710	710	1 200	1 640	1 220	940	940	1 450	1 880	1 440
825 × 120	740	740	1 240	1 690	1 280	1 000	1 000	1 510	1 960	1 520
825 × 125	740	740	1 250	1 700	1 290	1 000	1 000	1 520	1 970	1 530
825 × 140	770	770	1 280	1 750	1 350	1 050	1 050	1 570	2 030	1 600
825 × 200	860	860	1 400	1 890	1 540	1 200	1 200	1 750	2 230	1 840
825 × 220	900	900	1 450	1 940	1 560	1 260	1 260	1 810	2 310	1 890
825 × 225	900	900	1 450	1 960	1 610	1 270	1 270	1 820	2 330	1 940
825 × 280	1 000	1 000	1 570	2 100	1 790	1 420	1 420	1 990	2 520	2 160
825 × 320	1 110	1 110	1 710	2 250	1 970	1 560	1 560	2 160	2 700	2 370
825 × 325	1 110	1 110	1 710	2 270	1 980	1 570	1 570	2 170	2 730	2 380
825 × 425	1 280	1 280	1 920	2 510	2 290	1 830	1 830	2 470	3 060	2 780
825 × 525	1 450	1 450	2 110	2 750	2 620	2 100	2 100	2 770	3 410	3 200
1 020 × 75	750	750	1 380	1 770	1 310	1 020	1 020	1 660	2 040	1 550
1 020 × 80	750	750	1 380	1 840	1 310	1 020	1 020	1 660	2 110	1 560
1 020 × 100	780	780	1 400	1 890	1 380	1 080	1 080	1 700	2 190	1 660
1 020 × 120	810	810	1 440	1 950	1 460	1 140	1 140	1 780	2 280	1 760
1 020 × 125	810	810	1 450	1 960	1 470	1 150	1 150	1 790	2 300	1 780
1 020 × 140	850	850	1 490	2 020	1 530	1 200	1 200	1 910	2 370	1 860
1 020 × 200	960	960	1 630	2 180	1 760	1 380	1 380	2 070	2 610	2 150
1 020 × 220	1 000	1 000	1 650	2 220	1 840	1 450	1 450	2 090	2 700	2 250
1 020 × 225	1 000	1 000	1 680	2 260	1 850	1 460	1 460	2 150	2 720	2 270
1 020 × 280	1 110	1 110	1 820	2 430	2 070	1 640	1 640	2 360	2 960	2 550
1 020 × 320	1 240	1 240	1 980	2 600	2 240	1 800	1 800	2 560	3 170	2 750
1 020 × 325	1 240	1 240	1 980	2 620	2 250	1 810	1 810	2 570	3 200	2 770
1 020 × 425	1 430	1 430	2 220	2 900	2 660	2 130	2 130	2 930	3 600	3 290
1 020 × 525	1 620	1 620	2 460	3 190	3 050	2 450	2 450	3 290	4 020	3 800
1 025 × 75	750	750	1 380	1 770	1 310	1 020	1 020	1 660	2 040	1 560
1 025 × 80	750	750	1 380	1 840	1 310	1 020	1 020	1 660	2 140	1 560
1 025 × 100	780	780	1 400	1 890	1 380	1 080	1 080	1 700	2 190	1 660
1 025 × 120	810	810	1 440	1 950	1 460	1 140	1 140	1 780	2 280	1 760
1 025 × 125	810	810	1 450	1 960	1 470	1 150	1 150	1 790	2 300	1 780
1 025 × 140	850	850	1 490	2 020	1 530	1 200	1 200	1 630	2 370	1 860
1 025 × 200	960	960	1 630	2 180	1 760	1 380	1 380	2 070	2 610	2 150
1 025 × 220	1 000	1 000	1 540	2 220	1 840	1 450	1 450	2 090	2 700	2 250
1 025 × 225	1 000	1 000	1 680	2 260	1 850	1 460	1 460	2 150	2 720	2 270
1 025 × 280	1 110	1 110	1 820	2 430	2 070	1 640	1 640	2 360	2 960	2 550
1 025 × 320	1 240	1 240	1 980	2 600	2 240	1 800	1 800	2 560	3 170	2 750
1 025 × 325	1 240	1 240	1 980	2 620	2 250	1 810	1 810	2 570	3 200	2 770
1 025 × 425	1 430	1 430	2 220	2 900	2 660	2 130	2 130	2 930	3 600	3 290
1 025 × 525	1 620	1 620	2 460	3 190	3 050	2 450	2 450	3 290	4 020	3 800
1 225 × 75	820	820	1 530	2 060	1 460	1 140	1 140	1 860	2 380	1 750
1 225 × 80	810	810	1 520	2 060	1 460	1 140	1 140	1 860	2 390	1 760

VNM – vyústka nastavitelná										
Rozměr (mm)	Provedení a cena v Kč									
	Jednořadé					Dvouřadé				
	1	1/UR	1/R1	1/R2	1/R3	2	2/UR	2/R1	2/R2	2/R3
1 225 × 100	850	850	1 550	2 130	1 540	1 210	1 210	1 920	2 490	1 880
1 225 × 120	890	890	1 610	2 200	1 630	1 280	1 280	2 010	2 590	2 000
1 225 × 125	890	890	1 610	2 210	1 640	1 290	1 290	2 020	2 610	2 010
1 225 × 140	930	930	1 660	2 270	1 710	1 360	1 360	2 090	2 700	2 100
1 225 × 200	1 060	1 060	1 820	2 470	1 970	1 570	1 570	2 340	2 980	2 450
1 225 × 220	1 110	1 110	1 880	2 540	2 080	1 650	1 650	2 430	3 090	2 580
1 225 × 225	1 110	1 110	1 880	2 560	2 090	1 660	1 660	2 440	3 120	2 600
1 225 × 280	1 230	1 230	2 040	2 760	2 340	1 870	1 870	2 680	3 200	2 930
1 225 × 320	1 370	1 370	2 210	2 950	2 570	2 050	2 050	2 910	3 500	3 200
1 225 × 325	1 370	1 370	2 220	2 980	2 580	2 060	2 060	2 920	3 670	3 220
1 225 × 425	1 580	1 580	2 500	3 300	3 020	2 430	2 430	3 350	4 150	3 800
1 225 × 525	1 810	1 810	2 760	3 630	3 480	2 810	2 810	3 770	4 630	4 400

Typ	VNM	2	280 × 140	R1	S	TPM 015/01	Technické podmínky
Dvouřadé		1		-	-		Uchycení skryté (pérové sponky)
Jednořadé					S		Šrouby
Jmenovitý rozměr				R1			
Bez regulace				R2			
S regulací				R3			

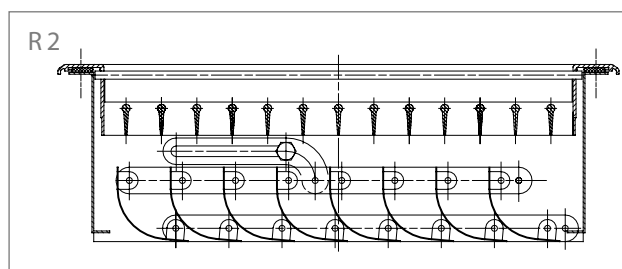
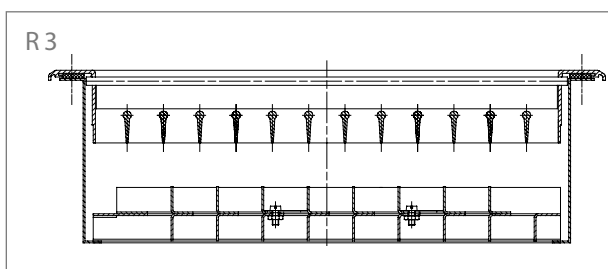
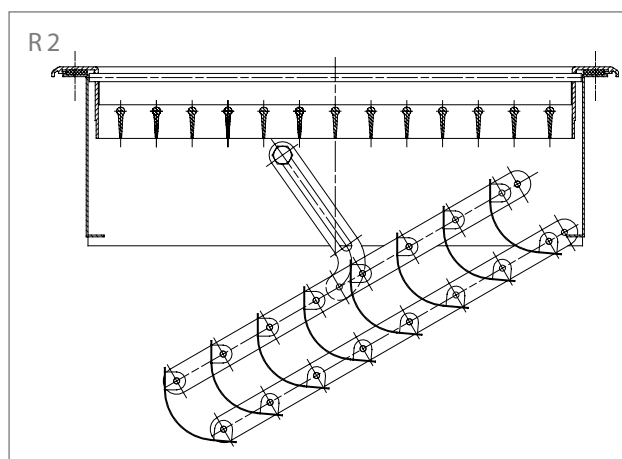
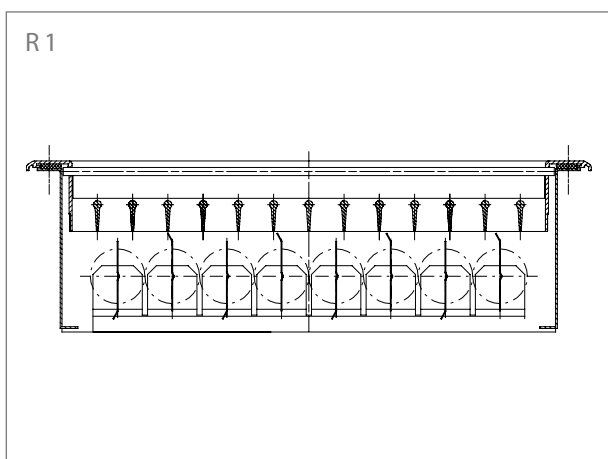

SVM (TPM 016/01)

Stěnová vyústka (PV)



SVM – Stěnová vyústka						
Rozměr (mm)	Provedení a cena v Kč					
	PV 12,5	PV 20	PV 12,5/UR	PV 20/UR	PV 12,5/R1	PV 20/R1
200 × 50	390	370	390	370	530	520
200 × 75	410	390	410	390	560	540
200 × 80	410	390	410	390	570	540
200 × 100	450	410	450	410	590	550
200 × 125	490	440	490	440	630	590
200 × 140	520	480	520	480	660	620
200 × 150	540	490	540	490	680	630
200 × 200	620	540	620	540	760	690
200 × 225	650	570	650	570	790	720
200 × 280	720	620	720	620	880	780
200 × 300	760	650	760	650	910	810
200 × 325	710	660	780	660	950	820
200 × 400	790	660	790	660	960	830
200 × 425	820	680	820	680	980	840
200 × 500	920	750	920	750	1 080	920
200 × 525	940	760	940	760	1 110	940
225 × 50	400	380	400	380	560	540
225 × 75	420	400	420	400	580	560
225 × 80	420	400	420	400	600	570
225 × 100	460	410	460	410	610	570
225 × 125	480	430	480	430	640	600
225 × 140	500	450	500	450	650	610
225 × 150	520	460	520	460	670	620
225 × 200	580	500	580	500	740	670
225 × 225	610	520	610	520	770	690
225 × 280	680	570	680	570	850	750
225 × 300	700	590	700	590	880	770
225 × 325	730	610	730	610	900	790
225 × 400	820	680	820	680	1 000	870
225 × 425	850	700	850	700	1 030	890
225 × 500	950	770	950	770	1 140	970
225 × 525	990	790	990	790	1 180	1 000
280 × 50	420	400	420	400	610	600
280 × 75	450	420	450	420	640	620
280 × 80	450	420	450	420	660	620

SVM – Stěnová vyústka						
Rozměr (mm)	Provedení a cena v Kč					
	PV 12,5	PV 20	PV 12,5/UR	PV 20/UR	PV 12,5/R1	PV 20/R1
280 × 100	480	440	480	440	670	630
280 × 125	510	460	510	460	710	660
280 × 140	530	480	530	480	720	670
280 × 150	550	490	550	490	740	680
280 × 200	620	530	620	530	820	730
280 × 225	650	550	650	550	860	760
280 × 280	730	610	730	610	940	820
280 × 300	750	630	750	630	970	850
280 × 325	790	650	790	650	1 000	870
280 × 400	890	730	890	730	1 110	960
280 × 425	920	750	920	750	1 140	980
280 × 500	1 030	820	1 030	820	1 260	1 070
280 × 525	1 050	840	1 050	840	1 300	1 090
300 × 50	420	410	420	410	620	600
300 × 75	450	430	450	430	650	620
300 × 80	450	430	450	430	660	630
300 × 100	490	440	490	440	680	630
300 × 125	520	460	520	460	710	660
300 × 140	540	480	540	480	730	680
300 × 150	560	500	560	500	750	690
300 × 200	630	540	630	540	830	740
300 × 225	660	560	660	560	870	770
300 × 280	740	620	740	620	950	830
300 × 300	770	640	770	640	990	860
300 × 325	800	660	800	660	1 020	880
300 × 400	900	740	900	740	1 130	970
300 × 425	940	760	940	760	1 160	990
300 × 500	1 050	840	1 050	840	1 280	1 080
300 × 525	1 080	860	1 080	860	1 320	1 110
325 × 50	430	420	430	420	640	620
325 × 75	460	440	460	440	670	640
325 × 80	460	440	460	440	690	650
325 × 100	500	450	500	450	700	660
325 × 125	530	470	530	470	740	680
325 × 140	550	490	550	490	760	700
325 × 150	570	510	570	510	780	720
325 × 200	650	550	650	550	860	770
325 × 225	680	570	680	570	900	800
325 × 280	760	630	760	630	990	870
325 × 300	790	660	790	660	1 030	900
325 × 325	820	680	820	680	1 060	920

SVM – Stěnová vyústka						
Rozměr (mm)	Provedení a cena v Kč					
	PV 12,5	PV 20	PV 12,5/UR	PV 20/UR	PV 12,5/R1	PV 20/R1
325 × 400	930	760	930	760	1 180	1 010
325 × 425	970	780	970	780	1 210	1 030
325 × 500	1 080	860	1 080	860	1 340	1 120
325 × 525	1 110	880	1 110	880	1 380	1 150
400 × 50	460	450	460	450	710	700
400 × 75	500	470	500	470	750	720
400 × 80	500	470	500	470	770	720
400 × 100	540	490	540	490	800	740
400 × 125	580	510	580	510	830	770
400 × 140	600	530	600	530	850	780
400 × 150	620	550	620	550	870	800
400 × 200	700	600	700	600	960	860
400 × 225	740	620	740	620	1 010	900
400 × 280	830	690	830	690	1 110	970
400 × 300	860	710	860	710	1 150	1 010
400 × 325	900	740	900	740	1 220	1 030
400 × 400	1 020	820	1 020	820	1 320	1 130
400 × 425	1 060	850	1 060	850	1 360	1 160
400 × 500	1 190	940	1 190	940	1 500	1 260
400 × 525	1 220	960	1 220	960	1 550	1 300
425 × 50	470	460	470	460	730	720
425 × 75	510	480	510	480	760	730
425 × 80	520	480	520	480	780	740
425 × 100	560	500	560	500	800	750
425 × 125	590	520	590	520	850	780
425 × 140	610	540	610	540	870	800
425 × 150	640	560	640	560	890	820
425 × 200	720	610	720	610	980	880
425 × 225	760	640	760	640	1 040	920
425 × 280	860	700	860	700	1 140	990
425 × 300	890	730	890	730	1 180	1 030
425 × 325	930	750	930	750	1 220	1 050
425 × 400	1 050	840	1 050	840	1 360	1 160
425 × 425	1 090	870	1 090	870	1 400	1 180
425 × 500	1 220	960	1 220	960	1 540	1 290
425 × 525	1 260	980	1 260	980	1 590	1 320
500 × 50	500	480	500	480	810	790
500 × 75	540	510	540	510	840	810
500 × 80	550	510	550	510	870	810
500 × 100	590	530	590	530	890	830
500 × 125	630	550	630	550	940	860

SVM – Stěnová vyústka						
Rozměr (mm)	Provedení a cena v Kč					
	PV 12,5	PV 20	PV 12,5/UR	PV 20/UR	PV 12,5/R1	PV 20/R1
500 x 140	650	580	650	580	960	880
500 x 150	680	600	680	600	980	910
500 x 200	770	650	770	650	1090	970
500x225	820	680	820	680	1 150	1 020
500x280	920	750	920	750	1 260	1 100
500x300	960	780	960	780	1 310	1 140
500x325	1 000	800	1 000	800	1 350	1 170
500x400	1 130	900	1 130	900	1 500	1 280
500x425	1 140	920	1 140	920	1 520	1 310
500x500	1 320	1 030	1 320	1 030	1 710	1 430
500x525	1 360	1 050	1 360	1 050	1 760	1 470
525x50	510	490	510	490	830	810
525x75	550	520	550	520	870	830
525x80	560	520	560	520	890	840
525x100	600	540	600	540	910	850
525x125	650	570	650	570	960	880
525x140	670	590	670	590	980	910
525x150	690	610	690	610	1 010	930
525x200	790	670	790	670	1 120	1 000
525x225	840	680	840	680	1 180	1 040
525x280	940	770	940	770	1 300	1 130
525x300	980	800	980	800	1 350	1 170
525x325	1 020	820	1 020	820	1 390	1 200
525x400	1 160	920	1 160	920	1 550	1 320
525x425	1 210	950	1 210	950	1 600	1 350
525x500	1 360	1 060	1 360	1 060	1 760	1 470
525x525	1 400	1 080	1 400	1 080	1 820	1 510
600x50	560	540	560	540	920	900
600x75	610	570	610	570	970	930
600x80	620	570	620	570	1 000	940
600x100	670	600	670	600	1 020	950
600x125	710	630	710	630	1 070	1 000
600x140	740	660	740	660	1 100	1 020
600x150	780	680	780	680	1 140	1 050
600x200	880	750	880	750	1 260	1 130
600x225	930	780	930	780	1 330	1 180
600x280	1 060	860	1 060	860	1 470	1 280
600x300	1 100	900	1 100	900	1 520	1 320
600x325	1 150	930	1 150	930	1 570	1 360
600x400	1 320	1 040	1 320	1 040	1 760	1 490
600x425	1 370	1 070	1 370	1 070	1 810	1 530

SVM – Stěnová vyústka						
Rozměr (mm)	Provedení a cena v Kč					
	PV 12,5	PV 20	PV 12,5/UR	PV 20/UR	PV 12,5/R1	PV 20/R1
600x500	1 540	1 190	1 540	1 190	2 000	1 660
600x525	1 580	1 210	1 580	1 210	2 060	1 710
625x50	570	550	570	550	950	930
625x72	620	580	620	580	1 000	960
625 x 80	640	580	640	580	1 020	960
625 x 100	680	610	680	610	1 040	980
625 x 125	730	650	730	650	1 100	1 020
625 x 140	760	670	760	670	1 130	1 050
625 x 150	790	700	790	700	1 170	1 080
625 x 200	900	760	900	760	1 290	1 160
625 x 225	950	790	950	790	1 360	1 210
625 x 280	1 080	880	1 080	880	1 510	1 310
625 x 300	1 120	920	1 120	920	1 560	1 360
625 x 325	1 170	950	1 170	950	1 610	1 390
625 x 400	1 350	1 060	1 350	1 060	1 810	1 530
625 x 425	1 400	1 090	1 400	1 090	1 860	1 570
625 x 500	1 580	1 210	1 580	1 210	2 060	1 710
625 x 525	1 640	1 250	1 640	1 250	2 140	1 770
700 x 50	600	580	600	580	1 010	990
700 x 75	660	610	660	610	1 070	1 020
700 x 80	670	610	670	610	1 090	1 030
700 x 100	720	640	720	640	1 120	1 050
700 x 125	770	680	770	680	1 180	1 100
700 x 140	800	710	800	710	1 210	1 130
700 x 150	840	730	840	730	1 250	1 150
700 x 200	960	800	960	800	1 390	1 240
700 x 225	1 010	830	1 010	830	1 470	1 300
700 x 280	1 150	930	1 150	930	1 620	1 410
700 x 300	1 190	960	1 190	960	1 680	1 460
700 x 325	1 250	1 000	1 250	1 000	1 730	1 490
700 x 400	1 430	1 120	1 430	1 120	1 940	1 640
700 x 425	1 490	1 150	1 490	1 150	2 000	1 680
700 x 500	1 670	1 280	1 670	1 280	2 210	1 830
700 x 525	1 720	1 310	1 720	1 310	2 280	1 880
725 x 50	610	590	610	590	1 040	1 010
725 x 75	670	620	670	620	1 090	1 050
725 x 80	680	620	680	620	1 120	1 080
725 x 100	730	650	730	650	1 150	1 070
725 x 125	780	690	780	690	1 210	1 120
725 x 140	810	720	810	720	1 240	1 150
725 x 150	850	750	850	750	1 290	1 180

SVM – Stěnová vyústka						
Rozměr (mm)	Provedení a cena v Kč					
	PV 12,5	PV 20	PV 12,5/UR	PV 20/UR	PV 12,5/R1	PV 20/R1
725 × 200	980	820	980	820	1 420	1 270
725 × 225	1 030	850	1 030	850	1 500	1 330
725 × 280	1 170	950	1 170	950	1 660	1 470
725 × 300	1 220	980	1 220	980	1 720	1 500
725 × 325	1 270	1 020	1 270	1 020	1 780	1 530
725 × 400	1 460	1 140	1 460	1 140	1 990	1 680
725 × 425	1 520	1 180	1 520	1 180	2 050	1 720
725 × 500	1 710	1 310	1 710	1 310	2 260	1 880
725 × 525	1 760	1 340	1 760	1 340	2 340	1 930
800 × 50	680	650	680	650	1 130	1 100
800 × 75	740	680	740	680	1 190	1 140
800 × 80	760	680	760	680	1 220	1 140
800 × 100	810	720	810	720	1 250	1 160
800 × 125	870	760	870	760	1 320	1 220
800 × 140	900	790	900	790	1 360	1 250
800 × 150	950	820	950	820	1 400	1 290
800 × 200	1 080	900	1 080	900	1 550	1 380
800 × 225	1 140	940	1 140	940	1 650	1 450
800 × 280	1 300	1 040	1 300	1 040	1 820	1 570
800 × 300	1 350	1 090	1 350	1 090	1 880	1 630
800 × 325	1 410	1 120	1 410	1 120	1 950	1 670
800 × 400	1 620	1 260	1 620	1 260	2 190	1 840
800 × 425	1 690	1 300	1 690	1 300	2 260	1 880
800 × 500	1 900	1 440	1 900	1 440	2 490	2 050
800 × 525	1 960	1 480	1 960	1 480	2 580	2 110
825 × 50	690	660	690	660	1 150	1 120
825 × 75	750	700	750	700	1 220	1 160
825 × 80	770	700	770	700	1 250	1 170
825 × 100	820	730	820	730	1 280	1 190
825 × 125	880	770	880	770	1 350	1 250
825 × 140	920	810	920	810	1 390	1 280
825 × 150	960	840	960	840	1 440	1 320
825 × 200	1 100	920	1 100	920	1 590	1 410
825 × 225	1 160	950	1 160	950	1 680	1 480
825 × 280	1 330	1 060	1 330	1 060	1 860	1 610
825 × 300	1 370	1 100	1 370	1 100	1 930	1 670
825 × 325	1 440	1 140	1 440	1 140	2 000	1 710
825 × 400	1 660	1 290	1 660	1 290	2 230	1 880
825 × 425	1 720	1 320	1 720	1 320	2 310	1 930
825 × 500	1 930	1 470	1 930	1 470	2 490	1 990
825 × 525	2 000	1 500	2 000	1 500	2 640	2 200

SVM – Stěnová vyústka						
Rozměr (mm)	Provedení a cena v Kč					
	PV 12,5	PV 20	PV 12,5/UR	PV 20/UR	PV 12,5/R1	PV 20/R1
900 × 50	700	670	700	670	1 200	1 170
900 × 75	780	720	780	720	1 280	1 220
900 × 80	800	720	800	720	1 310	1 230
900 × 100	850	760	850	760	1 350	1 250
900 × 125	920	800	920	800	1 430	1 310
900 × 140	960	840	960	840	1 460	1 350
900 × 150	1 000	870	1 000	870	1 510	1 390
900 × 200	1 150	960	1 150	960	1 680	1 490
900 × 225	1 220	990	1 220	990	1 780	1 560
900 × 280	1 390	1 110	1 390	1 110	1 970	1 700
900 × 300	1 440	1 150	1 440	1 150	2 040	1 760
900 × 325	1 510	1 190	1 510	1 190	2 110	1 810
900 × 400	1 740	1 340	1 740	1 340	2 370	1 990
900 × 425	1 810	1 380	1 810	1 380	2 450	2 050
900 × 500	2 030	1 540	2 030	1 540	2 710	2 230
900 × 525	2 100	1 570	2 100	1 570	2 790	2 290
925 × 50	720	690	720	690	1 230	1 200
925 × 75	790	730	790	730	1 300	1 240
925 × 80	810	730	810	730	1 340	1 250
925 × 100	870	770	870	770	1 370	1 270
925 × 125	940	810	940	810	1 450	1 330
925 × 140	970	850	970	850	1 490	1 370
925 × 150	1 020	880	1 020	880	1 540	1 410
925 × 200	1 170	970	1 170	970	1 700	1 510
925 × 225	1 240	1 010	1 240	1 010	1 810	1 590
925 × 280	1 420	1 120	1 420	1 120	2 000	1 720
925 × 300	1 460	1 170	1 460	1 170	2 070	1 790
925 × 325	1 530	1 210	1 530	1 210	2 150	1 840
925 × 400	1 770	1 360	1 770	1 360	2 400	2 020
925 × 425	1 840	1 400	1 840	1 400	2 490	2 080
925 × 500	2 070	1 560	2 070	1 560	2 750	2 270
925 × 525	2 130	1 600	2 130	1 600	2 850	2 330
1 000 × 50	770	730	770	730	1 320	1 290
1 000 × 75	840	780	840	780	1 400	1 340
1 000 × 80	870	770	870	780	1 440	1 340
1 000 × 100	920	810	920	810	1 470	1 370
1 000 × 125	1 000	860	1 000	860	1 560	1 430
1 000 × 140	1 040	900	1 040	900	1 600	1 480
1 000 × 150	1 090	940	1 090	940	1 660	1 510
1 000 × 200	1 250	1 030	1 250	1 030	1 830	1 630
1 000 × 225	1 320	1 070	1 320	1 070	1 950	1 710
1 000 × 280	1 510	1 200	1 510	1 200	2 160	1 860

SVM – Stěnová vyústka						
Rozměr (mm)	Provedení a cena v Kč					
	PV 12,5	PV 20	PV 12,5/UR	PV 20/UR	PV 12,5/R1	PV 20/R1
1 000 × 300	1 560	1 250	1 560	1 250	2 230	1 930
1 000 × 325	1 640	1 290	1 640	1 290	2 310	1 970
1 000 × 400	1 860	1 450	1 860	1 450	2 590	2 170
1 000 × 425	1 960	1 500	1 960	1 500	2 670	2 220
1 000 × 500	2 210	1 670	2 210	1 670	2 950	2 430
1 000 × 525	2 280	1 700	2 280	1 700	3 060	2 500
1 025 × 50	780	740	780	740	1 340	1 300
1 025 × 75	860	790	860	790	1 420	1 350
1 025 × 80	880	790	880	790	1 450	1 360
1 025 × 100	930	820	930	820	1 490	1 390
1 025 × 125	1 010	880	1 010	880	1 580	1 450
1 025 × 140	1 050	920	1 050	920	1 620	1 490
1 025 × 150	1 100	950	1 100	950	1 680	1 530
1 025 × 200	1 260	1 040	1 260	1 040	1 610	1 650
1 025 × 225	1 340	1 090	1 340	1 090	1 970	1 730
1 025 × 280	1 540	1 210	1 540	1 210	2 190	1 880
1 025 × 300	1 590	1 260	1 590	1 260	2 260	1 950
1 025 × 325	1 660	1 310	1 660	1 310	2 350	2 000
1 025 × 400	1 920	1 470	1 920	1 470	2 630	2 200
1 025 × 425	1 990	1 520	1 990	1 520	2 720	2 270
1 025 × 500	2 250	1 690	2 250	1 690	3 010	2 470
1 025 × 525	2 320	1 730	2 320	1 730	3 120	2 550
1 120 × 50	840	790	840	790	1 430	1 390
1 120 × 75	920	840	920	840	1 520	1 440
1 120 × 80	950	840	950	840	1 560	1 450
1 120 × 100	1 010	880	1 010	880	1 600	1 480
1 120 × 125	1 090	940	1 090	940	1 700	1 550
1 120 × 140	1 140	990	1 140	990	1 750	1 600
1 120 × 150	1 200	1 030	1 200	1 030	1 810	1 640
1 120 × 200	1 380	1 130	1 380	1 130	2 050	1 770
1 120 × 225	1 470	1 170	1 470	1 170	2 140	1 860
1 120 × 280	1 690	1 320	1 690	1 320	2 390	2 030
1 120 × 300	1 750	1 370	1 750	1 370	2 470	2 110
1 120 × 325	1 830	1 420	1 830	1 420	2 560	2 160
1 120 × 400	2 120	1 610	2 120	1 610	2 870	2 390
1 120 × 425	2 200	1 660	2 200	1 660	2 980	2 450
1 120 × 500	2 490	1 850	2 490	1 850	3 300	2 680
1 120 × 525	2 570	1 890	2 570	1 890	3 420	2 770
1 200 × 50	860	820	860	820	1 490	1 450
1 200 × 75	950	870	950	870	1 580	1 500
1 200 × 80	980	870	980	870	1 630	1 510
1 200 × 100	1 050	910	1 050	910	1 680	1 550

SVM – Stěnová vyústka						
Rozměr (mm)	Provedení a cena v Kč					
	PV 12,5	PV 20	PV 12,5/UR	PV 20/UR	PV 12,5/R1	PV 20/R1
1 200 × 125	1 140	970	1 140	970	1 780	1 630
1 200 × 140	1 180	1 020	1 180	1 020	1 830	1 670
1 200 × 150	1 240	1 060	1 240	1 060	1 900	1 720
1 200 × 200	1 440	1 170	1 440	1 170	2 110	1 850
1 200 × 225	1 530	1 220	1 530	1 220	2 240	1 950
1 200 × 280	1 760	1 370	1 760	1 370	2 500	2 120
1 200 × 300	1 820	1 420	1 820	1 420	2 580	2 210
1 200 × 325	1 910	1 470	1 910	1 470	2 680	2 260
1 200 × 400	2 200	1 670	2 200	1 670	3 010	2 500
1 200 × 425	2 290	1 690	2 290	1 690	3 120	2 570
1 200 × 500	2 590	1 920	2 590	1 920	3 460	2 810
1 200 × 525	2 680	1 970	2 680	1 970	3 580	2 900
1 225 × 50	870	830	870	830	1 520	1 480
1 225 × 75	960	880	960	880	1 620	1 530
1 225 × 80	1 000	880	1 000	880	1 660	1 540
1 225 × 100	1 060	920	1 060	920	1 700	1 570
1 225 × 125	1 150	990	1 150	990	1 790	1 650
1 225 × 140	1 200	1 030	1 200	1 030	1 850	1 700
1 225 × 150	1 260	1 080	1 260	1 080	1 920	1 740
1 225 × 200	1 460	1 180	1 460	1 180	2 140	1 880
1 225 × 225	1 550	1 210	1 550	1 210	2 280	1 970
1 225 × 280	1 780	1 380	1 780	1 380	2 540	2 150
1 225 × 300	1 840	1 440	1 840	1 440	2 620	2 240
1 225 × 325	1 930	1 490	1 930	1 490	2 720	2 300
1 225 × 400	2 230	1 690	2 230	1 690	3 050	2 530
1 225 × 425	2 320	1 740	2 320	1 740	3 150	2 600
1 225 × 500	2 630	1 950	2 630	1 950	3 510	2 850
1 225 × 525	2 720	1 990	2 720	1 990	3 640	2 940

SVM (TPM 016/01)

Stěnová vyústka (NV)



SVM – Stěnová vyústka				
Rozměr (mm)	Provedení a cena v Kč			
	NV 20	NV 20/UR	NV 20/R1	
200 × 50	350	350	510	
200 × 75	360	360	520	
200 × 80	360	360	520	
200 × 100	370	370	520	
200 × 125	390	390	540	
200 × 140	400	400	550	
200 × 150	400	400	550	
200 × 200	440	440	590	
200 × 225	450	450	610	
200 × 280	490	490	650	
200 × 300	520	520	690	
200 × 325	540	540	700	
200 × 400	580	580	760	
200 × 425	600	600	780	
200 × 500	660	660	840	
200 × 525	670	670	860	
225 × 50	360	360	530	
225 × 75	370	370	540	
225 × 80	370	370	550	
225 × 100	380	380	550	
225 × 125	400	400	570	
225 × 140	410	410	580	
225 × 150	410	410	580	
225 × 200	450	450	620	
225 × 225	460	460	640	
225 × 280	500	500	690	
225 × 300	540	540	730	
225 × 325	550	550	740	
225 × 400	610	610	800	
225 × 425	620	620	820	
225 × 500	680	680	880	
225 × 525	700	700	900	
280 × 50	380	380	580	
280 × 75	390	390	590	
280 × 80	390	390	600	

SVM – Stěnová vyústka				
Rozměr (mm)	Provedení a cena v Kč			
	NV 20	NV 20/UR	NV 20/R1	
280 × 100	410	410	600	
280 × 125	420	420	620	
280 × 140	440	440	640	
280 × 150	440	440	640	
280 × 200	480	480	690	
280 × 225	500	500	710	
280 × 280	540	540	760	
280 × 300	580	580	800	
280 × 325	590	590	820	
280 × 400	650	650	890	
280 × 425	670	670	900	
280 × 500	730	730	980	
280 × 525	750	750	1 000	
300 × 50	380	380	580	
300 × 75	400	400	600	
300 × 80	400	400	600	
300 × 100	410	410	610	
300 × 125	430	430	630	
300 × 140	440	440	640	
300 × 150	440	440	650	
300 × 200	490	490	690	
300 × 225	500	500	720	
300 × 280	540	540	770	
300 × 300	580	580	840	
300 × 325	600	600	840	
300 × 400	660	660	900	
300 × 425	680	680	920	
300 × 500	750	750	990	
300 × 525	760	760	1 020	
325 × 50	390	390	600	
325 × 75	410	410	620	
325 × 80	410	410	620	
325 × 100	420	420	630	
325 × 125	440	440	650	
325 × 140	450	450	660	
325 × 150	450	450	670	
325 × 200	500	500	720	
325 × 225	520	520	750	
325 × 280	580	580	820	
325 × 300	600	600	840	
325 × 325	620	620	860	
325 × 400	680	680	930	

SVM – Sténová vyústka			
Rozměr (mm)	Provedení a cena v Kč		
	NV 20	NV 20/UR	NV 20/R1
325 × 425	700	700	950
325 × 500	770	770	1 030
325 × 525	790	790	1 060
400 × 50	420	420	670
400 × 75	440	440	690
400 × 80	440	440	700
400 × 100	450	450	710
400 × 125	470	470	730
400 × 140	490	490	740
400 × 150	490	490	750
400 × 200	540	540	810
400 × 225	560	560	840
400 × 280	610	610	900
400 × 300	650	650	950
400 × 325	670	670	970
400 × 400	740	740	1 080
400 × 425	760	760	1 080
400 × 500	840	840	1 170
400 × 525	860	860	1 200
425 × 50	430	430	690
425 × 75	450	450	710
425 × 80	450	450	710
425 × 100	460	460	650
425 × 125	480	480	740
425 × 140	500	500	760
425 × 150	500	500	760
425 × 200	560	560	830
425 × 225	580	580	860
425 × 280	630	630	920
425 × 300	670	670	970
425 × 325	690	690	990
425 × 400	760	760	1 080
425 × 425	780	780	1 100
425 × 500	860	860	1 190
425 × 525	890	890	1 230
500 × 50	450	450	760
500 × 75	470	470	780
500 × 80	470	470	780
500 × 100	500	500	790
500 × 125	510	510	820
500 × 140	530	530	840
500 × 150	530	530	840

SVM – Stěnová vyústka			
Rozměr (mm)	Provedení a cena v Kč		
	NV 20	NV 20/UR	NV 20/R1
500 × 200	590	590	910
500 × 225	610	610	950
500 × 280	670	670	1 020
500 × 300	720	720	1 080
500 × 325	740	740	1 100
500 × 400	820	820	1 190
500 × 425	840	840	1 220
500 × 500	930	930	1 320
500 × 525	950	950	1 360
525 × 50	460	460	780
525 × 75	480	480	800
525 × 80	480	480	810
525 × 100	500	500	810
525 × 125	520	520	840
525 × 140	540	540	860
525 × 150	550	550	870
525 × 200	610	610	940
525 × 225	630	630	980
525 × 280	690	690	1 050
525 × 300	730	730	1 110
525 × 325	760	760	1 130
525 × 400	840	840	1 230
525 × 425	860	860	1 260
525 × 500	950	950	1 360
525 × 525	980	980	1 400
600 × 50	490	490	840
600 × 75	510	510	870
600 × 80	510	510	880
600 × 100	530	530	890
600 × 125	560	560	920
600 × 140	580	580	940
600 × 150	580	580	950
600 × 200	650	650	1 030
600 × 225	670	670	1 070
600 × 280	740	740	1 150
600 × 300	790	790	1 210
600 × 325	810	810	1 240
600 × 400	910	910	1 350
600 × 425	930	930	1 380
600 × 500	1 030	1 030	1 500
600 × 525	1 060	1 060	1 550
625 × 50	500	500	870

SVM – Sténová vyústka			
Rozměr (mm)	Provedení a cena v Kč		
	NV 20	NV 20/UR	NV 20/R1
625 × 72	520	520	890
625 × 80	520	520	890
625 × 100	540	540	910
625 × 125	570	570	940
625 × 140	590	590	970
625 × 150	590	590	970
625 × 200	660	660	1 050
625 × 225	690	690	1 100
625 × 280	760	760	1 190
625 × 300	810	810	1 250
625 × 325	830	830	1 270
625 × 400	930	930	1 390
625 × 425	950	950	1 420
625 × 500	1 050	1 050	1 540
625 × 525	1 080	1 080	1 590
700 × 50	520	520	930
700 × 75	550	550	960
700 × 80	550	550	960
700 × 100	570	570	980
700 × 125	600	600	1 010
700 × 140	620	620	1 040
700 × 150	630	630	1 040
700 × 200	700	700	1 130
700 × 225	730	730	1 190
700 × 280	800	800	1 280
700 × 300	850	850	1 340
700 × 325	880	880	1 370
700 × 400	980	980	1 490
700 × 425	1 010	1 010	1 530
700 × 500	1 120	1 120	1 660
700 × 525	1 150	1 150	1 710
725 × 50	530	530	950
725 × 75	560	560	980
725 × 80	560	560	990
725 × 100	580	580	1 000
725 × 125	610	610	1 040
725 × 140	640	640	1 070
725 × 150	640	640	1 070
725 × 200	720	720	1 160
725 × 225	750	750	1 220
725 × 280	820	820	1 310
725 × 300	870	870	1 370

SVM – Stěnová vyústka			
Rozměr (mm)	Provedení a cena v Kč		
	NV 20	NV 20/UR	NV 20/R1
725 × 325	900	900	1 410
725 × 400	1 010	1 010	1 530
725 × 425	1 030	1 030	1 570
725 × 500	1 150	1 150	1 710
725 × 525	1 160	1 160	1 760
800 × 50	660	660	1 100
800 × 75	690	690	1 130
800 × 80	690	690	1 140
800 × 100	720	720	1 160
800 × 125	750	750	1 200
800 × 140	780	780	1 240
800 × 150	790	790	1 240
800 × 200	880	880	1 350
800 × 225	920	920	1 410
800 × 280	1 010	1 010	1 520
800 × 300	1 090	1 090	1 620
800 × 325	1 120	1 120	1 660
800 × 400	1 250	1 250	1 810
800 × 425	1 290	1 290	1 850
800 × 500	1 420	1 420	2 010
800 × 525	1 460	1 460	2 070
825 × 50	670	670	1 120
825 × 75	700	700	1 160
825 × 80	700	700	1 160
825 × 100	730	730	1 190
825 × 125	770	770	1 230
825 × 140	800	800	1 260
825 × 150	800	800	1 270
825 × 200	900	900	1 380
825 × 225	930	930	1 440
825 × 280	1 030	1 030	1 560
825 × 300	1 110	1 110	1 650
825 × 325	1 140	1 140	1 690
825 × 400	1 270	1 270	1 850
825 × 425	1 310	1 310	1 900
825 × 500	1 440	1 440	1 950
825 × 525	1 480	1 480	2 130
900 × 50	690	690	1 180
900 × 75	730	730	1 220
900 × 80	730	730	1 220
900 × 100	760	760	1 250
900 × 125	790	790	1 290

SVM – Stěnová vyústka			
Rozměr (mm)	Provedení a cena v Kč		
	NV 20	NV 20/UR	NV 20/R1
900 × 140	830	830	1 330
900 × 150	830	830	1 330
900 × 200	930	930	1 450
900 × 225	970	970	1 520
900 × 280	1 070	1 070	1 640
900 × 300	1 150	1 150	1 740
900 × 325	1 190	1 190	1 790
900 × 400	1 330	1 330	1 950
900 × 425	1 370	1 370	2 000
900 × 500	1 510	1 510	2 180
900 × 525	1 550	1 550	2 240
925 × 50	700	700	1 190
925 × 75	740	740	1 230
925 × 80	740	740	1 240
925 × 100	770	770	1 260
925 × 125	800	800	1 310
925 × 140	840	840	1 350
925 × 150	840	840	1 360
925 × 200	950	950	1 480
925 × 225	980	980	1 550
925 × 280	1 090	1 090	1 670
925 × 300	1 170	1 170	1 770
925 × 325	1 210	1 210	1 810
925 × 400	1 350	1 350	1 980
925 × 425	1 390	1 390	2 030
925 × 500	1 530	1 530	2 210
925 × 525	1 570	1 570	2 280
1 000 × 50	720	720	1 260
1 000 × 75	760	760	1 310
1 000 × 80	760	760	1 310
1 000 × 100	800	800	1 340
1 000 × 125	840	840	1 390
1 000 × 140	870	870	1 430
1 000 × 150	880	880	1 440
1 000 × 200	980	980	1 560
1 000 × 225	1 020	1 020	1 640
1 000 × 280	1 130	1 130	1 770
1 000 × 300	1 220	1 220	1 870
1 000 × 325	1 260	1 260	1 920
1 000 × 400	1 410	1 410	2 100
1 000 × 425	1 450	1 450	2 150
1 000 × 500	1 600	1 600	2 330

SVM – Stěnová vyústka			
Rozměr (mm)	Provedení a cena v Kč		
	NV 20	NV 20/UR	NV 20/R1
1 000 × 525	1 640	1 640	2 410
1 025 × 50	730	730	1 280
1 025 × 75	770	770	1 320
1 025 × 80	770	770	1 330
1 025 × 100	810	810	1 360
1 025 × 125	850	850	1 410
1 025 × 140	880	880	1 450
1 025 × 150	890	890	1 450
1 025 × 200	1 000	1 000	1 580
1 025 × 225	1 040	1 040	1 660
1 025 × 280	1 150	1 150	1 800
1 025 × 300	1 230	1 230	1 900
1 025 × 325	1 270	1 270	1 950
1 025 × 400	1 430	1 430	2 130
1 025 × 425	1 470	1 470	2 190
1 025 × 500	1 620	1 620	2 380
1 025 × 525	1 670	1 670	2 450
1 120 × 50	760	760	1 340
1 120 × 75	810	810	1 390
1 120 × 80	810	810	1 400
1 120 × 100	850	850	1 430
1 120 × 125	890	890	1 480
1 120 × 140	930	930	1 520
1 120 × 150	940	940	1 530
1 120 × 200	1 050	1 050	1 670
1 120 × 225	1 090	1 090	1 750
1 120 × 280	1 210	1 210	1 900
1 120 × 300	1 300	1 300	2 010
1 120 × 325	1 340	1 340	2 060
1 120 × 400	1 500	1 500	2 250
1 120 × 425	1 540	1 540	2 310
1 120 × 500	1 710	1 710	2 520
1 120 × 525	1 760	1 760	2 600
1 200 × 50	790	790	1 400
1 200 × 75	830	830	1 450
1 200 × 80	830	830	1 460
1 200 × 100	880	880	1 490
1 200 × 125	920	920	1 550
1 200 × 140	960	960	1 600
1 200 × 150	960	960	1 600
1 200 × 200	1 090	1 090	1 750
1 200 × 225	1 130	1 130	1 840

SVM – Sténová vyústka			
Rozměr (mm)	Provedení a cena v Kč		
	NV 20	NV 20/UR	NV 20/R1
1 200 × 280	1 260	1 260	1 990
1 200 × 300	1 350	1 350	2 100
1 200 × 325	1 390	1 390	2 160
1 200 × 400	1 560	1 560	2 360
1 200 × 425	1 610	1 610	2 420
1 200 × 500	1 780	1 780	2 640
1 200 × 525	1 830	1 830	2 720
1 225 × 50	800	800	1 430
1 225 × 75	840	840	1 480
1 225 × 80	840	840	1 490
1 225 × 100	890	890	1 510
1 225 × 125	920	920	1 570
1 225 × 140	970	970	1 620
1 225 × 150	980	980	1 630
1 225 × 200	1 100	1 100	1 770
1 225 × 225	1 150	1 150	1 870
1 225 × 280	1 270	1 270	2 020
1 225 × 300	1 370	1 370	2 130
1 225 × 325	1 410	1 410	2 190
1 225 × 400	1 580	1 580	2 390
1 225 × 425	1 630	1 630	2 450
1 225 × 500	1 800	1 800	2 670
1 225 × 525	1 850	1 850	2 760

SVM (TPM 016/01)

Stěnová vyústka (PS)



SVM – Stěnová vyústka						
Rozměr (mm)	Provedení a cena v Kč					
	PS 12,5	PS 20	PS 12,5/UR	PS 20/UR	PS 12,5/R1	PS 12,5/R1
200 × 100	460	420	460	420	610	570
200 × 125	470	430	470	430	640	590
200 × 140	490	440	490	440	640	600
200 × 150	490	440	490	440	650	600
200 × 200	530	470	530	470	690	640
200 × 225	540	480	540	480	720	660
200 × 280	580	510	580	510	760	690
200 × 300	590	520	590	520	780	710
200 × 325	610	540	610	540	790	720
200 × 400	660	580	660	580	850	770
200 × 425	680	590	680	590	870	780
200 × 500	730	630	730	630	940	840
200 × 525	750	650	750	650	960	860
225 × 100	480	430	480	430	650	600
225 × 125	500	440	500	440	670	620
225 × 140	510	450	510	450	680	630
225 × 150	510	460	510	460	690	640
225 × 200	550	490	550	490	730	670
225 × 225	570	500	570	500	760	690
225 × 280	610	530	610	530	810	730
225 × 300	620	540	620	540	830	740
225 × 325	640	560	640	560	840	760
225 × 400	700	600	700	600	910	810
225 × 425	720	610	720	610	930	830
225 × 500	780	660	780	660	1 000	880
225 × 525	800	670	800	670	1 030	910
280 × 100	530	470	530	470	750	680
280 × 125	550	490	550	490	760	700
280 × 140	560	500	560	500	790	710
280 × 150	570	500	570	500	800	720
280 × 200	620	530	620	530	840	760
280 × 225	640	550	640	550	870	780
280 × 280	680	580	680	580	920	820
280 × 300	700	600	700	600	950	840
280 × 325	720	610	720	610	970	860
280 × 400	790	660	790	660	1 050	920

SVM – Sténová vyústka						
Rozměr (mm)	Provedení a cena v Kč					
	PS 12,5	PS 20	PS 12,5/UR	PS 20/UR	PS 12,5/R1	PS 12,5/R1
280 × 425	810	680	810	680	1 070	940
280 × 500	880	730	880	730	1 150	1 000
280 × 525	900	750	900	750	1 190	1 030
300 × 100	540	480	540	480	760	690
300 × 125	560	500	560	500	780	720
300 × 140	580	510	580	510	790	720
300 × 150	590	530	590	530	800	730
300 × 200	630	550	630	550	850	770
300 × 225	650	570	650	570	890	800
300 × 280	700	600	700	600	940	840
300 × 300	720	620	720	620	970	860
300 × 325	740	630	740	630	990	880
300 × 400	810	680	810	680	1 070	940
300 × 425	830	700	830	700	1 100	960
300 × 500	900	750	900	750	1 180	1 030
300 × 525	930	770	930	770	1 210	940
325 × 100	560	500	560	500	790	720
325 × 125	580	510	580	510	810	740
325 × 140	600	530	600	530	830	750
325 × 150	610	530	610	530	840	760
325 × 200	660	570	660	570	890	800
325 × 225	680	580	680	580	930	830
325 × 280	730	620	730	620	990	880
325 × 300	750	630	750	630	1 020	900
325 × 325	770	650	770	650	1 040	920
325 × 400	840	700	840	700	1 120	980
325 × 425	870	720	870	720	1 150	1 000
325 × 500	940	780	940	780	1 240	1 070
325 × 525	970	800	970	800	1 280	1 100
400 × 100	630	550	630	550	910	830
400 × 125	660	570	660	570	940	850
400 × 140	680	590	680	590	950	860
400 × 150	690	590	690	590	960	870
400 × 200	740	630	740	630	1 030	920
400 × 225	770	650	770	650	1 070	950
400 × 280	830	690	830	690	1 140	1 010
400 × 300	850	710	850	710	1 180	1 030
400 × 325	880	730	880	730	1 210	1 060
400 × 400	960	790	960	790	1 300	1 130
400 × 425	990	810	990	810	1 340	1 160
400 × 500	1 080	870	1 080	870	1 440	1 240
400 × 525	1 110	900	1 110	900	1 480	1 270

SVM – Stěnová vyústka						
Rozměr (mm)	Provedení a cena v Kč					
	PS 12,5	PS 20	PS 12,5/UR	PS 20/UR	PS 12,5/R1	PS 12,5/R1
425 × 100	650	570	650	570	860	770
425 × 125	680	590	680	590	960	870
425 × 140	700	600	700	600	980	880
425 × 150	710	610	710	610	990	890
425 × 200	770	650	770	650	1 060	940
425 × 225	800	670	800	670	1 100	980
425 × 280	860	710	860	710	1 180	1 030
425 × 300	880	730	880	730	1 210	1 060
425 × 325	910	750	910	750	1 240	1 080
425 × 400	1 000	810	1 000	810	1 340	1 160
425 × 425	1 030	830	1 030	830	1 380	1 180
425 × 500	1 120	900	1 120	900	1 490	1 270
425 × 525	1 150	920	1 150	920	1 530	1 300
500 × 100	720	620	720	620	1 040	940
500 × 125	750	640	750	640	1 080	970
500 × 140	770	660	770	660	1 100	990
500 × 150	780	660	780	660	1 110	1 000
500 × 200	850	710	850	710	1 190	1 060
500 × 225	880	730	880	730	1 240	1 100
500 × 280	950	780	950	780	1 330	1 160
500 × 300	980	800	980	800	1 370	1 190
500 × 325	1 010	820	1 010	820	1 400	1 220
500 × 400	1 110	890	1 110	890	1 520	1 310
500 × 425	1 140	920	1 140	920	1 560	1 340
500 × 500	1 240	990	1 240	990	1 680	1 430
500 × 525	1 280	1 010	1 280	1 010	1 730	1 470
525 × 100	740	630	740	630	1 070	960
525 × 125	770	660	770	660	1 110	1 000
525 × 140	790	670	790	670	1 130	1 010
525 × 150	800	680	800	680	1 150	1 020
525 × 200	870	730	870	730	1 230	1 090
525 × 225	910	750	910	750	1 280	1 130
525 × 280	980	800	980	800	1 370	1 200
525 × 300	1 010	820	1 010	820	1 410	1 230
525 × 325	1 040	850	1 040	850	1 450	1 250
525 × 400	1 140	920	1 140	920	1 570	1 350
525 × 425	1 180	940	1 180	940	1 610	1 380
525 × 500	1 280	1 010	1 280	1 010	1 740	1 470
525 × 525	1 320	1 040	1 320	1 040	1 800	1 520

SVM (TPM 016/01)

Stěnová vyústka (NS)

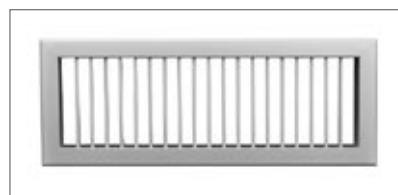

SVM Stěnová vyústka (NS)

SVM – Stěnová vyústka			
Rozměr (mm)	Provedení a cena v Kč		
	NS 20	NS 20/UR	NS 20/R1
200 × 50	360	360	540
200 × 75	370	370	560
200 × 80	370	370	560
200 × 100	380	380	560
200 × 125	400	400	580
200 × 140	410	410	580
200 × 150	410	410	590
200 × 200	440	440	620
200 × 225	450	450	640
200 × 280	480	480	680
200 × 300	490	490	690
200 × 325	500	500	700
200 × 400	540	540	750
200 × 425	560	560	770
200 × 500	600	600	820
200 × 525	610	610	840
225 × 50	370	370	570
225 × 75	390	390	580
225 × 80	380	390	590
225 × 100	400	400	590
225 × 125	410	410	610
225 × 140	420	420	610
225 × 150	420	420	620
225 × 200	450	450	650
225 × 225	460	460	680
225 × 280	490	490	710
225 × 300	510	510	730
225 × 325	520	520	740
225 × 400	560	560	790
225 × 425	580	580	810
225 × 500	620	620	870
225 × 525	630	630	880
280 × 50	400	400	630
280 × 75	410	410	640
280 × 80	410	410	650
280 × 100	420	420	650

SVM – Stěnová vyústka			
Rozměr (mm)	Provedení a cena v Kč		
	NS 20	NS 20/UR	NS 20/R1
280 × 125	440	440	670
280 × 140	450	450	680
280 × 150	460	460	690
280 × 200	490	490	730
280 × 225	500	500	750
280 × 280	540	540	800
280 × 300	550	550	820
280 × 325	570	570	830
280 × 400	610	610	890
280 × 425	630	630	910
280 × 500	680	680	980
280 × 525	690	690	1 000
300 × 50	430	430	660
300 × 75	440	440	670
300 × 80	440	440	680
300 × 100	450	450	680
300 × 125	470	470	700
300 × 140	480	480	710
300 × 150	490	490	720
300 × 200	520	520	760
300 × 225	540	540	790
300 × 280	570	570	830
300 × 300	580	580	850
300 × 325	600	600	870
300 × 400	650	650	930
300 × 425	670	670	950
300 × 500	720	720	1 020
300 × 525	730	730	1 040
325 × 50	440	440	680
325 × 75	450	450	700
325 × 80	450	450	700
325 × 100	460	460	710
325 × 125	480	480	730
325 × 140	490	490	740
325 × 150	500	500	750
325 × 200	530	530	790
325 × 225	550	550	820
325 × 280	590	590	860
325 × 300	600	600	890
325 × 325	620	620	900
325 × 400	670	670	970
325 × 425	690	690	990

SVM – Sténová výústka			
Rozměr (mm)	Provedení a cena v Kč		
	NS 20	NS 20/UR	NS 20/R1
325 × 500	740	740	1 060
325 × 525	760	760	1 080
400 × 50	470	470	750
400 × 75	490	490	770
400 × 80	490	490	780
400 × 100	500	500	800
400 × 125	520	520	810
400 × 140	530	530	830
400 × 150	540	540	840
400 × 200	580	580	890
400 × 225	600	600	920
400 × 280	640	640	970
400 × 300	660	660	1 000
400 × 325	680	680	1 020
400 × 400	740	740	1 100
400 × 425	760	760	1 120
400 × 500	820	820	1 200
400 × 525	840	840	1 230
425 × 50	480	480	770
425 × 75	500	500	790
425 × 80	500	500	800
425 × 100	510	510	810
425 × 125	530	530	830
425 × 140	550	550	840
425 × 150	550	550	850
425 × 200	600	600	900
425 × 225	620	620	940
425 × 280	660	660	1 000
425 × 300	680	680	1 020
425 × 325	700	700	1 040
425 × 400	760	760	1 120
425 × 425	780	780	1 150
425 × 500	840	840	1 230
425 × 525	860	860	1 260
500 × 50	510	510	860
500 × 75	530	530	880
500 × 80	530	530	880
500 × 100	550	550	890
500 × 125	580	580	930
500 × 140	590	590	940
500 × 150	600	600	950
500 × 200	640	640	1 010

SVM – Stěnová vyústka			
Rozměr (mm)	Provedení a cena v Kč		
	NS 20	NS 20/UR	NS 20/R1
500 × 225	670	670	1 050
500 × 280	720	720	1 120
500 × 300	740	740	1 150
500 × 325	760	760	1 170
500 × 400	830	830	1 260
500 × 425	850	850	1 290
500 × 500	920	920	1 380
500 × 525	960	960	1 420
525 × 50	520	520	890
525 × 75	550	550	900
525 × 80	550	550	910
525 × 100	570	570	920
525 × 125	590	590	950
525 × 140	600	600	960
525 × 150	610	610	980
525 × 200	660	660	1 040
525 × 225	660	660	1 080
525 × 280	730	730	1 150
525 × 300	750	750	1 180
525 × 325	780	780	1 200
525 × 400	850	850	1 300
525 × 425	870	870	1 330
525 × 500	950	950	1 420
525 × 525	970	970	1 460
600 × 50	560	560	960
600 × 75	580	580	980
600 × 80	580	580	990
600 × 100	600	600	1 000
600 × 125	630	630	1 040
600 × 140	650	650	1 050
600 × 150	660	660	1 070
600 × 200	710	710	1 140
600 × 225	740	740	1 190
600 × 280	790	790	1 260
600 × 300	810	810	1 290
600 × 325	840	840	1 330
600 × 400	930	930	1 430
600 × 425	930	930	1 460
600 × 500	1 030	1 030	1 570
600 × 525	1 050	1 050	1 610
625 × 50	570	570	980
625 × 72	590	590	1 010

SVM – Sténová výústka			
Rozměr (mm)	Provedení a cena v Kč		
	NS 20	NS 20/UR	NS 20/R1
625 × 80	590	590	1 020
625 × 100	620	620	1 030
625 × 125	640	640	1 060
625 × 140	660	660	1 080
625 × 150	670	670	1 100
625 × 200	720	720	1 170
625 × 225	750	750	1 220
625 × 280	810	810	1 290
625 × 300	830	830	1 330
625 × 325	860	860	1 360
625 × 400	940	940	1 470
625 × 425	970	970	1 500
625 × 500	1 050	1 050	1 610
625 × 525	1 070	1 070	1 660
700 × 50	650	650	1 100
700 × 75	680	680	1 130
700 × 80	680	680	1 140
700 × 100	700	700	1 150
700 × 125	730	730	1 190
700 × 140	750	750	1 210
700 × 150	760	760	1 230
700 × 200	820	820	1 310
700 × 225	850	850	1 360
700 × 280	910	910	1 450
700 × 300	940	940	1 490
700 × 325	970	970	1 520
700 × 400	1 050	1 050	1 640
700 × 425	1 080	1 080	1 670
700 × 500	1 180	1 180	1 800
700 × 525	1 200	1 200	1 850
725 × 50	660	660	1 130
725 × 75	690	690	1 160
725 × 80	690	690	1 170
725 × 100	720	720	1 180
725 × 125	740	740	1 220
725 × 140	760	760	1 240
725 × 150	770	770	1 260
725 × 200	830	830	1 340
725 × 225	870	870	1 400
725 × 280	930	930	1 480
725 × 300	950	950	1 520
725 × 325	980	980	1 560

SVM – Stěnová vyústka			
Rozměr (mm)	Provedení a cena v Kč		
	NS 20	NS 20/UR	NS 20/R1
725 × 400	1 070	1 070	1 680
725 × 425	1 110	1 110	1 720
725 × 500	1 200	1 200	1 840
725 × 525	1 230	1 230	1 890
800 × 50	730	730	1 220
800 × 75	760	760	1 260
800 × 80	760	760	1 270
800 × 100	790	790	1 280
800 × 125	820	820	1 330
800 × 140	840	840	1 350
800 × 150	850	850	1 370
800 × 200	920	920	1 450
800 × 225	950	950	1 520
800 × 280	1 020	1 020	1 610
800 × 300	1 050	1 050	1 650
800 × 325	1 070	1 070	1 690
800 × 400	1 180	1 180	1 820
800 × 425	1 210	1 210	1 860
800 × 500	1 310	1 310	2 000
800 × 525	1 300	1 300	2 060
825 × 50	740	740	1 250
825 × 75	770	770	1 280
825 × 80	770	770	1 300
825 × 100	800	800	1 310
825 × 125	830	830	1 360
825 × 140	850	850	1 380
825 × 150	870	870	1 400
825 × 200	930	930	1 480
825 × 225	970	970	1 550
825 × 280	1 040	1 040	1 640
825 × 300	1 070	1 070	1 690
825 × 325	1 100	1 100	1 730
825 × 400	1 200	1 200	1 860
825 × 425	1 240	1 240	1 910
825 × 500	1 340	1 340	1 980
825 × 525	1 370	1 370	2 110
900 × 50	770	770	1 320
900 × 75	810	810	1 360
900 × 80	810	810	1 370
900 × 100	840	840	1 390
900 × 125	870	870	1 440
900 × 140	900	900	1 460

SVM – Sténová výústka			
Rozměr (mm)	Provedení a cena v Kč		
	NS 20	NS 20/UR	NS 20/R1
900 × 150	910	910	1 480
900 × 200	980	980	1 570
900 × 225	1 020	1 020	1 650
900 × 280	1 090	1 090	1 750
900 × 300	1 120	1 120	1 800
900 × 325	1 160	1 160	1 840
900 × 400	1 270	1 270	1 990
900 × 425	1 300	1 300	2 040
900 × 500	1 420	1 420	2 190
900 × 525	1 450	1 450	2 250
925 × 50	780	780	1 340
925 × 75	820	820	1 380
925 × 80	820	820	1 390
925 × 100	850	850	1 410
925 × 125	890	890	1 460
925 × 140	910	910	1 480
925 × 150	920	920	1 500
925 × 200	1 000	1 000	1 600
925 × 225	1 030	1 030	1 670
925 × 280	1 110	1 110	1 770
925 × 300	1 140	1 140	1 830
925 × 325	1 180	1 180	1 870
925 × 400	1 290	1 290	2 020
925 × 425	1 320	1 320	2 070
925 × 500	1 440	1 440	2 220
925 × 525	1 470	1 470	2 290
1 000 × 50	810	810	1 420
1 000 × 75	850	850	1 460
1 000 × 80	850	850	1 470
1 000 × 100	890	890	1 490
1 000 × 125	930	930	1 550
1 000 × 140	950	950	1 580
1 000 × 150	970	970	1 600
1 000 × 200	1 040	1 040	1 700
1 000 × 225	1 080	1 080	1 780
1 000 × 280	1 170	1 170	1 890
1 000 × 300	1 200	1 200	1 950
1 000 × 325	1 240	1 240	2 000
1 000 × 400	1 360	1 360	2 150
1 000 × 425	1 400	1 400	2 200
1 000 × 500	1 520	1 520	2 360
1 000 × 525	1 550	1 550	2 440

SVM – Stěnová vyústka			
Rozměr (mm)	Provedení a cena v Kč		
	NS 20	NS 20/UR	NS 20/R1
1 025 × 50	820	820	1 430
1 025 × 75	860	860	1 480
1 025 × 80	860	860	1 490
1 025 × 100	900	900	1 510
1 025 × 125	940	940	1 570
1 025 × 140	960	960	1 600
1 025 × 150	980	980	1 620
1 025 × 200	1 060	1 060	1 720
1 025 × 225	1 100	1 100	1 800
1 025 × 280	1 180	1 180	1 920
1 025 × 300	1 220	1 220	1 970
1 025 × 325	1 260	1 260	2 020
1 025 × 400	1 380	1 380	2 180
1 025 × 425	1 420	1 420	2 240
1 025 × 500	1 540	1 540	2 410
1 025 × 525	1 570	1 570	2 480
1 120 × 50	890	890	1 540
1 120 × 75	930	930	1 590
1 120 × 80	930	930	1 600
1 120 × 100	970	970	1 620
1 120 × 125	1 020	1 020	1 680
1 120 × 140	1 040	1 040	1 710
1 120 × 150	1 060	1 060	1 730
1 120 × 200	1 140	1 140	1 850
1 120 × 225	1 190	1 190	1 940
1 120 × 280	1 280	1 280	2 060
1 120 × 300	1 320	1 320	2 120
1 120 × 325	1 360	1 360	2 180
1 120 × 400	1 490	1 490	2 350
1 120 × 425	1 530	1 530	2 410
1 120 × 500	1 660	1 660	2 590
1 120 × 525	1 700	1 700	2 670
1 200 × 50	920	920	1 600
1 200 × 75	970	970	1 650
1 200 × 80	970	970	1 670
1 200 × 100	1 010	1 010	1 700
1 200 × 125	1 050	1 050	1 760
1 200 × 140	1 080	1 080	1 800
1 200 × 150	1 100	1 100	1 820
1 200 × 200	1 190	1 190	1 940
1 200 × 225	1 240	1 240	2 030
1 200 × 280	1 340	1 340	2 170

SVM – Stěnová vyústka			
Rozměr (mm)	Provedení a cena v Kč		
	NS 20	NS 20/UR	NS 20/R1
1 200 × 300	1 370	1 370	2 230
1 200 × 325	1 420	1 420	2 290
1 200 × 400	1 560	1 560	2 470
1 200 × 425	1 600	1 600	2 540
1 200 × 500	1 740	1 740	2 730
1 200 × 525	1 780	1 780	2 810
1 225 × 50	930	930	1 640
1 225 × 75	940	940	1 690
1 225 × 80	980	980	1 700
1 225 × 100	1 020	1 020	1 720
1 225 × 125	1 070	1 070	1 790
1 225 × 140	1 100	1 100	1 820
1 225 × 150	1 110	1 110	1 840
1 225 × 200	1 210	1 210	1 970
1 225 × 225	1 250	1 250	2 060
1 225 × 280	1 350	1 350	2 200
1 225 × 300	1 390	1 390	2 260
1 225 × 325	1 440	1 440	2 320
1 225 × 400	1 580	1 580	2 500
1 225 × 425	1 620	1 620	2 560
1 225 × 500	1 760	1 760	2 770
1 225 × 525	1 810	1 810	2 850

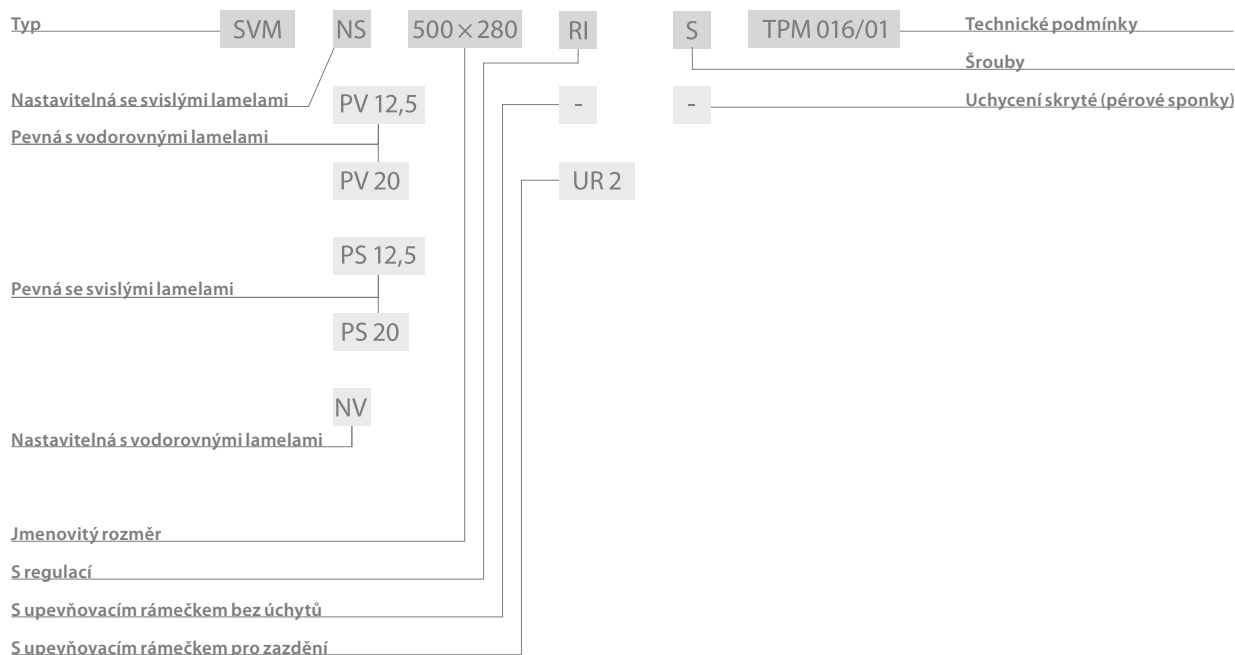

U skrytého uchycení se nepřiřítává cena rámečku, ta je součástí základní ceny SVM.

VNKM (TPM 034/04)

Vyústka nastavitelná pro kruhové potrubí

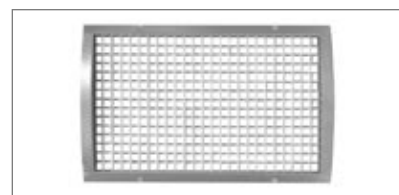

VNKM – Vyústka nastavitelná pro kruhové potrubí								
Rozměr (mm)	Provedení a cena v Kč							
	1	1/R1	1/R2	1/R3	2	2/R1	2/R2	2/R3
225 × 75	290	520	710	580	320	560	750	610
325 × 75	330	640	850	670	370	680	890	710
425 × 75	360	730	1 010	760	410	780	1 050	800
525 × 75	410	860	1 190	870	470	920	1 250	920
625 × 75	450	970	1 280	950	520	1 040	1 350	1 020
825 × 75	530	1 180	1 570	1 140	640	1 290	1 680	1 250
1 025 × 75	610	1 390	1 850	1 320	720	1 510	1 970	1 430
1 225 × 75	690	1 590	2 130	1 500	810	1 720	2 260	1 620
225 × 85	290	530	720	580	330	560	750	620
325 × 85	340	650	860	680	380	690	900	720
425 × 85	370	750	1 020	770	420	790	1 060	820
525 × 85	420	870	1 210	880	480	930	1 260	940
625 × 85	460	990	1 300	970	530	1 050	1 360	1 040
825 × 85	540	1 200	1 590	1 160	650	1 310	1 690	1 270
1 025 × 85	620	1 410	1 870	1 350	740	1 530	1 990	1 460
1 225 × 85	710	1 620	2 160	1 530	830	1 750	2 290	1 660
225 × 125	310	550	750	630	360	600	800	680
325 × 125	360	670	900	680	420	730	960	740
425 × 125	400	780	1 070	840	470	850	1 140	910
525 × 125	450	910	1 270	960	540	1 000	1 360	1 050
625 × 125	490	1 020	1 370	1 070	600	1 130	1 480	1 170
825 × 125	590	1 250	1 680	1 290	740	1 410	1 840	1 450
1 025 × 125	680	1 470	1 920	1 500	860	1 650	2 100	1 680
1 225 × 125	770	1 690	2 230	1 710	970	1 890	2 430	1 910
225 × 225	350	620	830	730	440	710	920	820
325 × 225	420	760	1 000	860	530	870	1 110	970
425 × 225	470	880	1 190	1 010	600	1 020	1 330	1 150
525 × 225	530	1 030	1 410	1 170	700	1 200	1 580	1 340
625 × 225	590	1 160	1 540	1 300	790	1 370	1 740	1 510
825 × 225	700	1 420	1 890	1 590	990	1 710	2 180	1 880
1 025 × 225	820	1 680	2 250	1 870	1 160	2 010	2 580	2 200
1 225 × 225	940	1 930	2 600	2 140	1 320	2 300	2 980	2 520
225 × 325	410	690	920	840	550	830	1 060	980
325 × 325	480	850	1 120	1 020	650	1 020	1 290	1 190
425 × 325	540	990	1 340	1 190	760	1 200	1 550	1 400

VNKM – Vyústka nastavitelná pro kruhové potrubí								
Rozměr (mm)	Provedení a cena v Kč							
	1	1/R1	1/R2	1/R3	2	2/R1	2/R2	2/R3
525 × 325	620	1 160	1 600	1 380	880	1 420	1 860	1 630
625 × 325	690	1 310	1 750	1 550	990	1 610	2 050	1 850
825 × 325	830	1 600	2 170	1 870	1 250	2 010	2 580	2 280
1 025 × 325	970	1 890	2 590	2 240	1 460	2 380	3 080	2 730
1 225 × 325	1 120	2 180	2 940	2 580	1 670	2 730	3 500	3 140

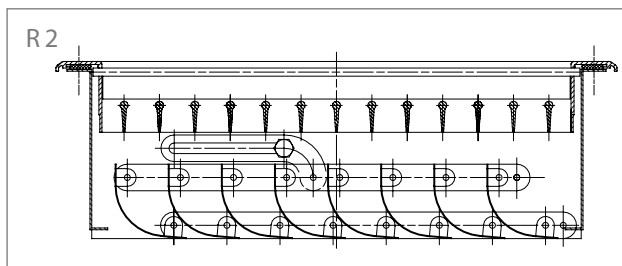
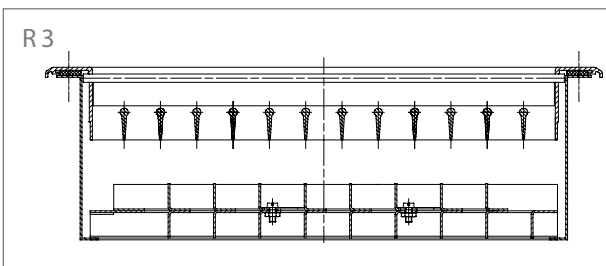
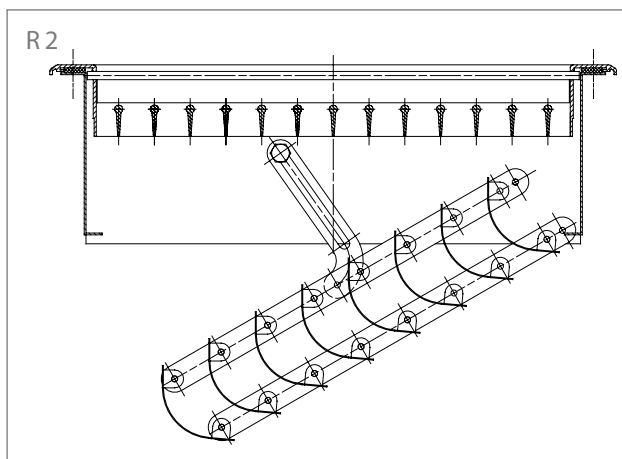
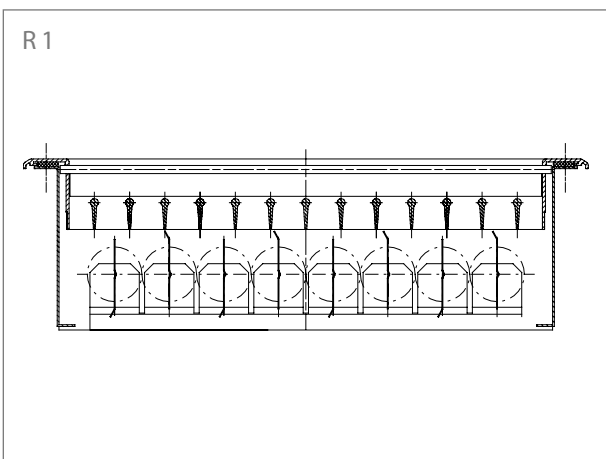
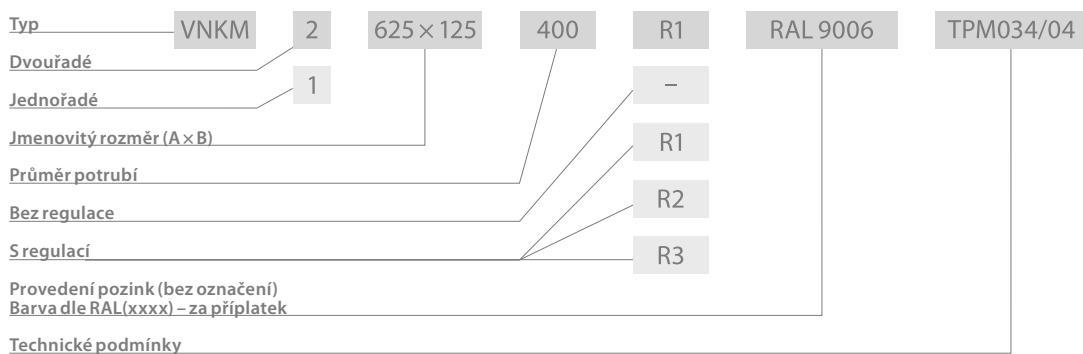

Ekobox (TPM 037/04)



Ekobox				
Rozměr (mm)	Provedení a cena v Kč			
	V/P/R	V/O/R	S/P/R	S/O/R
250	470	430	-	-
300	520	470	500	430
400	670	580	610	520
500	860	750	770	620
600	1130	910	980	780
625	1130	1160	1100	880
825	1880	1800	1870	1870

DDM II (TPM 072/08)

Dýza s dalekým dosahem



DDM II – Dýza s dalekým dosahem nastavitelná				
Rozměr (mm)	Provedení a cena v Kč			
	N	.45	.55	.57
ø 100	1 100	4 000	3 860	4 850
ø 125	1 280	4 200	4 070	5 060
ø 160	1 680	4 600	4 470	5 460
ø 200	2 060	5 540	5 410	6 880
ø 250	2 680	6 130	5 990	7 460
ø 315	3 120	6 440	6 300	7 770
ø 400	4 380	7 620	7 490	8 960

DDM II – Dýza s dalekým dosahem pevná	
Rozměr (mm)	Provedení a cena v Kč
	P
ø 90	307
ø 130	425
ø 180	781
ø 250	819
ø 315	1 550
ø 400	2 274

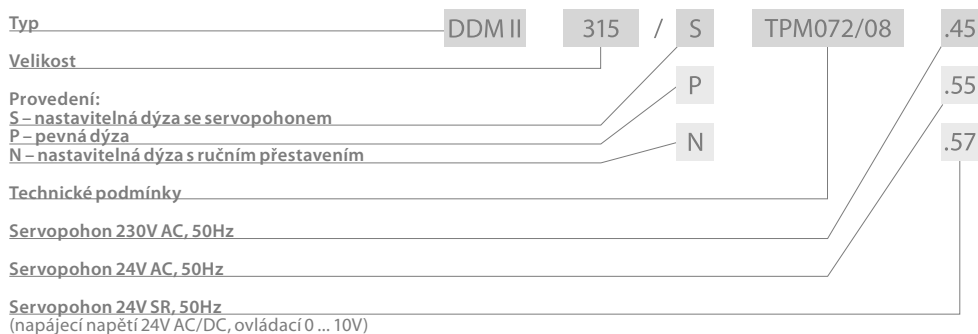

HELIOS (TPM 049/05)

Infrazářič – plynový

HELIOS: tmavý plynový infrazářič

HELIOS D: tmavý plynový infrazářič s dvoustupňovým výkonem

U: provedení s vratnou trubicí tvaru U

I: provedení jednotrubkové tvaru I

15: provedení pro nástěnné zavěšení

+: provedení s izolovaným reflektorem



HELIOS U (jednostupňový výkon)					
Výkonová řada	Dodávaný výkon (kW)	Provedení a cena v Kč			
		U	s izolací U+	nakloněný U/15	nakloněný s izolací U/15+
HELIOS 10	6,2 - 10,6	25 900	27 600	26 500	28 600
HELIOS 20	11,2 - 19,1	28 600	31 300	29 500	32 700
HELIOS 30	17,4 - 29,2	32 300	35 800	33 600	37 900
HELIOS 40	21,1 - 36,1	34 900	39 300	36 400	41 800
HELIOS 50	26,5 - 44,5	40 300	45 300	43 200	48 200

HELIOS I (jednostupňový výkon)					
Výkonová řada	Dodávaný výkon (kW)	Provedení a cena v Kč			
		I	s izolací I+	nakloněný I/15	nakloněný s izolací I/15+
HELIOS 10	6,2 - 10,6	27 200	30 500	27 900	31 200
HELIOS 20	11,2 - 21,3	31 600	36 500	32 600	37 400
HELIOS 30	17,4 - 32,4	36 600	43 100	38 000	44 400
HELIOS 40	21,1 - 36,5	40 500	48 700	42 200	50 200

HELIOS UD (dvoustupňový výkon)						
Výkonová řada	Dvoustupňový výkon (kW)		Provedení a cena v Kč			
	Jmenovitý	Minimální	UD	s izolací UD+	nakloněný UD/15	nakloněný s izolací UD/15+
HELIOS 10	10,6	6,2	26 900	28 600	27 500	29 600
HELIOS 20	19,1	11,2	29 600	32 300	30 500	33 700
HELIOS 30	29,2	17,4	33 300	36 800	34 600	38 900
HELIOS 40	36,1	21,1	35 900	40 300	37 400	42 800
HELIOS 50	44,5	26,5	41 000	46 000	43 900	48 900

HELIOS ID (dvoustupňový výkon)						
Výkonová řada	Dvoustupňový výkon (kW)		Provedení a cena v Kč			
	Jmenovitý	Minimální	ID	s izolací ID+	nakloněný ID/15	nakloněný s izolací ID/15+
HELIOS 10	10,6	6,2	28 200	31 500	28 900	32 200
HELIOS 20	21,3	11,2	32 600	37 500	33 600	38 400
HELIOS 30	32,4	17,4	37 600	44 100	39 000	45 400
HELIOS 40	36,5	21,1	41 500	49 700	43 200	52 200

HELIOS SUPER UD (Dvoustupňový výkon)						
Výkonová řada	Dvoustupňový výkon (kW)		Provedení a cena v Kč			
	Jmenovitý	Minimální	UD	s izolací UD+	Řada EKONOMIK	
		UDE			s izolací UDE+	
HELIOS 33 S	33,3	18,2	51 000	55 500	44 000	47 500
HELIOS 50 S	44,5	26,5	58 600	65 500	54 400	60 900

Zaregulování zářiče, zaškolení obsluhy, do výšky instalace 8 m: 1000 Kč/ks

HELIOS (TPM 049/05)

Příslušenství k infrazářičům



Regulace ovládání			
Počet ovládání zářičů	Cena v Kč		
	OI	OIX	HELREG
1	3 100	4 780	9 300
2	3 560	5 280	9 740
3	3 870	5 680	10 300
4	4 830	6 540	11 540
5	5 370	6 730	12 080
6	5 800	7 140	12 770

Možnosti ovládání

OVLÁDACÍ SKŘÍŇ – OI: umožňuje provoz zapnuto / vypnuto ruční přepnutí výkonu max / min (při použití zářiče s dvoustupňovým výkonem)

OVLÁDACÍ SKŘÍŇ – OIX: ovládací skříň se standartním termostatem a týdenním programem ruční přepnutí výkonu max / min (při použití zářiče s dvoustupňovým výkonem)

OVLÁDACÍ SKŘÍŇ – HELREG: plně automatická dvoustupňová regulace podle předem nastavených teplot: Možnost napojení na PC – MONITORING

- týdenní program – 10 teplotních změn denně
- ochrana proti neoprávněnému zásahu
- v ceně regulace je 1 čidlo sálavého tepla

Příslušenství – plynové hadice	
Příslušenství	Cena v Kč
Plynová hadice s koncovkou G 1/2" délka 1000 mm	490
Plynová hadice s koncovkou G 3/4" délka 1000 mm	560

MONZUN TEPLOVODNÍ (TPM 063/07)

Teplovzdušné jednotky – teplovodní



MONZUN TEPLOVODNÍ				
	Průtok (m ³ /h)	Delta (°C)	Výkon při 90/70 °C (kW)	Cena v Kč
MONZUN VH 1.1.150	1 500	21,5	11,00	11 300
MONZUN VH 1.1.180	1 800	19,7	12,00	11 500
MONZUN VH 1.1.220	2 200	17,9	13,30	11 600
MONZUN VH 1.2.150	1 500	38,6	19,60	12 300
MONZUN VH 1.2.200	1 900	35,0	22,50	12 400
MONZUN VH 1.2.250	2 400	31,7	25,80	12 850
MONZUN VH 1.3.180	1 700	48,4	27,90	13 300
MONZUN VH 1.3.220	2 100	44,8	31,90	13 750
MONZUN VH 1.4.150	1 500	59,4	30,20	14 250
MONZUN VH 1.4.180	1 850	55,8	35,00	14 700
MONZUN VH 2.1.200	2 000	23,2	15,80	12 650
MONZUN VH 2.1.250	2 600	20,5	18,00	12 850
MONZUN VH 2.1.400	3 800	17,0	22,00	13 450
MONZUN VH 2.2.250	2 400	37,9	30,80	14 100
MONZUN VH 2.2.320	3 200	33,6	36,50	14 750
MONZUN VH 2.2.420	4 250	29,7	42,80	15 450
MONZUN VH 2.3.220	2 100	52,5	37,40	15 350

MONZUN				
	Průtok (m ³ /h)	Delta (°C)	Výkon při 90/70 °C (kW)	Cena v Kč
MONZUN VH 2.3.280	2 800	47,5	45,00	15 950
MONZUN VH 2.3.400	3 800	42,4	54,60	16 650
MONZUN VH 2.4.200	1 900	63,3	40,80	16 650
MONZUN VH 2.4.250	2 500	58,6	49,70	17 300
MONZUN VH 2.4.350	3 500	52,7	62,50	18 050
MONZUN VH 3.1.450	4 600	20,9	32,60	15 850
MONZUN VH 3.1.600	6 000	18,4	37,30	17 250
MONZUN VH 3.1.800	7 800	16,1	42,60	17 700
MONZUN VH 3.2.420	4 250	38,1	54,90	17 950
MONZUN VH 3.2.560	5 500	34,3	63,90	19 400
MONZUN VH 3.2.700	6 750	31,4	71,80	19 800
MONZUN VH 3.3.400	4 000	51,3	69,60	20 050
MONZUN VH 3.3.500	5 000	47,5	80,50	21 600
MONZUN VH 3.3.600	5 900	44,7	89,40	22 050
MONZUN VH 3.4.350	3 700	61,7	77,40	22 350
MONZUN VH 3.4.450	4 500	58,3	89,00	23 850
MONZUN VH 3.4.520	5 200	55,8	98,40	24 250

MONZUN TEPLOVODNÍ (TPM 063/07)

Příslušenství



MONZUN TEPLOVODNÍ – Směšovací komory		
	Provedení	Cena v Kč
Komora směšovací	KS 1F .01 (s filtrem)	4 950
	KS 2F .01 (s filtrem)	5 300
	KS 3F .01 (s filtrem)	6 600
	KS 1F .57 (s filtrem)	8 650
	KS 2F .57 (s filtrem)	9 000
	KS 3F .57 (s filtrem)	10 250
	KS 1 .01	4 450
	KS 2 .01	4 900
	KS 3 .01	6 050
	KS 1 .57	8 150
	KS 2 .57	8 550
KS 3 .57	9 750	
Konzole jednotky	KJ	800
Závěs jednotky	ZJ	300
Konzole sestavy	KS 1	2 000
	KS 2	2 100
	KS 3	2 200
Závěs sestavy	ZS 1	150
	ZS 2	170
	ZS 3	190

Ovládání směšovací komory

.01 – ruční ovládání směšovací komory

.57 – ovládání směšovací komory servopohonem

MONZUN TEPLOVODNÍ – Ostatní příslušenství					
	Velikost	Cena v Kč		Velikost	Cena v Kč
Díl průchodový	DP 1	1 400	Vyústění svislá úhlová	1	1 150
	DP 2	1 600		2	1 500
	DP 3	2 350		3	2 000
Díl střešní	DS 1	1 850	Vyústění stranová	1	350
	DS 2	2 050		2	500
	DS 3	2 500		3	800
Hlavice střešní	HS 1	4 250	Vyústění svislá křížová	1	650
	HS 2	4 450		2	850
	HS 3	5 500		3	1 200
Žaluzie protidešťová	ZP 1	3 250			
	ZP 2	3 600			
	ZP 3	4 600			

MONZUN – VH (TPM 040/05)

Teplovzdušné jednotky plynové

MONZUN - VH - E: teplovzdušná jednotka s axiálním ventilátorem a jednostupňovým výkonem

MONZUN - VH - ED+: teplovzdušná jednotka s axiálním ventilátorem a dvoustupňovým výkonem

MONZUN - VH - EM+: teplovzdušná jednotka s axiálním ventilátorem a plynule regulovaným výkonem v rozsahu max.-min.



MONZUN - VH					
Typ	Výkon (kW)		Provedení a cena v Kč		
	Jmenovitý	Minimální	VH-E	VH-ED+	VH-EM+
MONZUN VH 130	15,0	6,5	40 000	45 600	48 000
MONZUN VH 180	22,0	10,4	41 500	47 200	49 700
MONZUN VH 250	29,6	12,0	45 050	50 700	53 300
MONZUN VH 300	35,5	12,2	46 500	52 100	54 600
MONZUN VH 350	40,6	15,8	46 900	52 600	55 100
MONZUN VH 400	46,4	19,3	55 200	60 800	63 400
MONZUN VH 450	52,2	21,3	55 200	60 800	63 400
MONZUN VH 520	60,9	26,2	55 900	61 500	64 000
MONZUN VH 600	69,6	28,1	70 100	75 800	79 200
MONZUN VH 700	81,2	35,6	70 100	75 800	79 300

Zaregulování agregátu, zaškolení obsluhy: 1 000,- /ks

MONZUN - CV (TPM 040/05)

Teplovzdušné jednotky plynové

MONZUN - CV - E: teplovzdušná jednotka s radiálním ventilátorem a jednostupňovým výkonem

MONZUN - CV - ED+: teplovzdušná jednotka s radiálním ventilátorem a dvoustupňovým výkonem

MONZUN - CV - EM+: teplovzdušná jednotka s radiálním ventilátorem a plynule regulovaným výkonem v rozsahu max.-min.



MONZUN - CV					
Typ	Výkon (kW)		Provedení a cena v Kč		
	Jmenovitý	Minimální	CV - E	CV - ED+	CV - EM+
MONZUN 130	15,0	6,5	50 500	56 100	58 600
MONZUN 180	22,0	10,4	50 600	56 200	58 700
MONZUN 250	29,6	12,0	54 700	60 000	62 600
MONZUN 300	35,5	12,2	56 100	61 400	63 900
MONZUN 350	40,6	15,8	58 700	63 900	66 400
MONZUN 400	46,4	19,3	66 900	72 200	74 700
MONZUN 450	52,2	21,3	66 900	72 200	74 700
MONZUN 520	60,9	26,2	67 500	72 800	75 300
MONZUN 600	69,6	28,1	93 400	102 400	105 900
MONZUN 700	81,2	35,6	93 400	102 600	106 000
MONZUN 800	92,8	40,8	104 500	106 000	107 000

Zaregulování agregátu, zaškolení obsluhy: 1 000,- /ks

MONZUN – VH RTI (TPM 046/05)

Teplovzdušné jednotky plynové,
se směšovací komorou

VH - RTI-E+: teplovzdušná jednotka s axiálním ventilátorem, směšovací komorou a jednostupňovým výkonem

VH - RTI-ED+: teplovzdušná jednotka s axiálním ventilátorem, směšovací komorou a dvoustupňovým výkonem

VH - RTI-EM+: teplovzdušná jednotka s axiálním ventilátorem, směšovací komorou a plynule regulovaným výkonem v rozsahu max.-min.



MONZUN VH/CV – RTI								
Provedení	Výkon		Provedení a cena v Kč					
	Jmenovitý	Minimální	VH - RTI-E + žaluzie		VH - RTI-ED+ žaluzie		VH - RTI-EM+ žaluzie	
			.01	.57	.01	.57	.01	.57
MONZUN 130	15,0	6,5	51 800	55 500	52 200	55 700	55 000	58 200
MONZUN 180	22,0	10,4	53 400	56 900	53 600	57 300	56 500	59 800
MONZUN 250	29,6	12,0	57 500	61 000	58 000	62 800	60 500	63 900
MONZUN 300	35,5	12,2	58 800	62 400	60 000	63 000	61 800	65 300
MONZUN 350	40,6	15,8	59 300	62 900	60 300	63 500	62 500	65 700
MONZUN 400	46,4	19,3	68 400	72 000	69 400	72 500	72 400	74 800
MONZUN 450	52,2	21,3	68 400	72 000	69 400	72 500	72 400	74 800
MONZUN 520	60,9	26,2	68 900	72 400	70 000	72 900	73 400	75 200
MONZUN 600	69,6	28,1	85 100	88 600	86 100	89 100	88 900	92 400
MONZUN 700	81,2	35,6	85 200	88 700	86 200	89 200	89 000	92 500

Zaregulování agregátu, zaškolení obsluhy: 1 000,- /ks

Ovládání směšovací komory

.01 – ruční ovládání směšovací komory

.57 – ovládání směšovací komory servopohonem

MONZUN – CV RTI (TPM 046/05)

Teplovzdušné jednotky plynové,
se směšovací komorou

CV - RTI-E+: teplovzdušná jednotka s radiálním ventilátorem, směšovací komorou a jednostupňovým výkonem

CV - RTI-ED+: teplovzdušná jednotka s radiálním ventilátorem, směšovací komorou a dvoustupňovým výkonem

CV - RTI-EM+: teplovzdušná jednotka s radiálním ventilátorem, směšovací komorou a plynule regulovaným výkonem v rozsahu max.-min.



MONZUN CV – RTI – žaluzie								
Typ	Výkon (kW)		Provedení a cena v Kč					
	Jmenovitý	Minimální	CV – RTI – E + žaluzie		CV – RTI – ED + žaluzie		CV – RTI – EM + žaluzie	
			.01	.57	.01	.57	.01	.57
MONZUN 130	15,0	6,5	64 900	68 500	65 500	69 000	67 700	71 500
MONZUN 180	22,0	10,4	64 900	68 600	65 500	70 300	67 700	71 500
MONZUN 250	29,6	12,0	69 900	73 500	70 500	74 000	72 700	76 500
MONZUN 300	35,5	12,2	71 300	74 800	71 900	75 500	74 200	77 700
MONZUN 350	40,6	15,8	73 900	77 400	74 500	77 900	76 700	80 500
MONZUN 400	46,4	19,3	82 900	86 400	83 500	87 000	85 900	89 300
MONZUN 450	52,2	21,3	82 900	86 400	83 500	87 000	85 900	89 300
MONZUN 520	60,9	26,2	83 300	86 900	83 900	87 500	86 100	90 000
MONZUN 600	69,6	28,1	114 700	118 300	115 300	118 900	118 500	122 000
MONZUN 700	81,2	35,6	114 800	118 400	115 400	119 000	118 600	122 200
MONZUN 800	92,8	40,8	138 500	141 800	139 200	142 500	142 500	146 000

MONZUN CV – RTI – příruba								
Typ	Výkon (kW)		Provedení a cena v Kč					
	Jmenovitý	Minimální	CV – RTI – E + příruba		CV – RTI – ED + příruba		CV – RTI – EM + příruba	
			.01	.57	.01	.57	.01	.57
MONZUN 130	15,0	6,5	64 900	68 800	65 200	69 700	67 100	70 700
MONZUN 180	22,0	10,4	65 800	69 400	66 200	69 900	68 700	72 200
MONZUN 250	29,6	12,0	72 500	75 700	72 700	76 300	75 300	78 800
MONZUN 300	35,5	12,2	73 900	77 400	74 100	78 000	76 700	80 300
MONZUN 350	40,6	15,8	95 400	99 000	95 700	99 800	98 300	101 800
MONZUN 400	46,4	19,3	104 200	107 800	104 500	108 500	107 000	110 700
MONZUN 450	52,2	21,3	104 200	107 800	104 500	108 500	107 000	110 700
MONZUN 520	60,9	26,2	104 600	108 200	104 900	108 800	107 500	111 500
MONZUN 600	69,6	28,1	137 900	141 500	138 300	142 100	141 700	145 200
MONZUN 700	81,2	35,6	138 000	141 600	138 400	142 200	141 800	145 400
MONZUN 800	92,8	40,8	138 500	141 900	138 600	142 900	141 900	145 900

MONZUN – CV EUROKLIM (TPM 043/05)

Teplovzdušné jednotky – plynové

Plynové ohřívače s modulací výkonu CV EUROKLIM jsou určeny pro ekologické vytápění místností a hal. Jsou koncipovány pro maximálně účinné vytápění prostorů jako součást vzduchotechnických rozvodů.

CV-EUROKLIM INTERIER: teplovzdušná jednotka s plynule regulovaným výkonem v rozsahu max.-min.pro použití v interieru v barvě RAL.

CV-EUROKLIM POZINK: teplovzdušná jednotka s plynule regulovaným výkonem v rozsahu max.-min.pro použití v interieru v provedení pozink.

CV-EUROKLIM EXTERIER: teplovzdušná jednotka s plynule regulovaným výkonem v rozsahu max.-min.pro použití v exterieru.



MONZUN CV - EUROKLIM					
Typ	Výkon (kW)		Provedení a cena v Kč		
	Jmenovitý	Minimální	Interier	Exterier	Pozink
MONZUN 130	15,0	6,5	45 800	54 700	45 300
MONZUN 180	22,0	10,4	47 300	56 200	46 800
MONZUN 250	29,6	12	51 800	62 200	51 000
MONZUN 300	35,5	12,2	53 200	63 500	52 300
MONZUN 350	40,6	15,8	53 300	63 600	52 400
MONZUN 400	46,4	19,3	77 400	88 600	76 400
MONZUN 450	52,2	21,3	77 400	88 600	76 400
MONZUN 520	60,9	26,2	77 900	89 800	76 900
MONZUN 600	69,6	28,1	95 400	108 000	94 200
MONZUN 700	81,2	35,6	95 500	108 200	94 400
MONZUN 800	92,8	40,8	95 700	108 400	94 600

Zaregulování agregátu, zaškolení obsluhy: 1 000,- /ks

PŘÍSLUŠENSTVÍ MONZUN

Plynové jednotky

Možnosti ovládání

TERMOSTAT EUR 091N: Ovládání termostatem

OVLÁDACÍ SKŘÍŇ OM: Ovládací skříň pro jednostupňovou nebo dvoustupňovou regulaci výkonu, ruční přepínání mezi stupni výkonu bez termostatu s týdenním programem

OVLÁDACÍ SKŘÍŇ OMT: Ovládací skříň pro jednostupňovou nebo dvoustupňovou regulaci výkonu,

ruční přepínání mezi stupni výkonu, vybavena termostatem s týdenním programem, umožňuje přepnutí režimu zima - léto

OVLÁDACÍ SKŘÍŇ REMON: Ovládací skříň pro dvoustupňovou nebo modulovatelnou regulaci výkonu, plně automatické přepínání mezi stupni výkonu, nastavení týdenního programu

Regulace	
Typ	Cena v Kč
Termostat EUR 091N	850
Ovládací skříň OM	2 300
Ovládací skříň OMT	3 420
Ovládací skříň REMON	9 890

Ostatní příslušenství	
	Cena v Kč
Nosné konzole – sada	1 500
Otočný nástavec	1 900
Plynová hadice G 1/2" délka 1000 mm	490
Plynová hadice G 3/4" délka 1000 mm	560

Ostatní příslušenství – výusti	
Typ jednotky	Cena v Kč
VH/CV 130-180	1 800
VH/CV 250-350	2 000
VH/CV 400-520	2 200
VH/CV 600/800	2 500

Příslušenství MONZUN VH/CV - RTI			
Velikost jednotky	Cena v Kč		
	Kapsový filtr	Průchodový díl	Protidešťová žaluzie
MONZUN 130	1 950	1 450	3 250
MONZUN 180	1 950	1 450	3 250
MONZUN 250	2 150	1 650	3 700
MONZUN 300	2 150	1 650	3 700
MONZUN 350	2 150	1 650	3 700
MONZUN 400	2 650	1 800	4 000
MONZUN 450	2 650	1 800	4 000
MONZUN 520	2 650	1 800	4 000
MONZUN 600	4 000	2 000	4 250
MONZUN 700	4 000	2 000	4 250
MONZUN 800	4 000	2 000	4 250

MONZUN – Premix (TPM 068/08)

Teplovzdušné kondenzační jednotky – plynové

VHMT1: s axiálním jednofázovým ventilátorem bez směšovací komory, $\Delta T > 25K$

VHMT2: s axiálním jednofázovým ventilátorem bez směšovací komory, $\Delta T < 25K$

VHMRT1: s axiálním jednofázovým ventilátorem s možností připojení směšovací komory s filtrem EU2, $\Delta T > 25K$

VHMRT2: s axiálním třífázovým ventilátorem s možností připojení směšovací komory s filtrem EU2, $\Delta T < 25K$



MONZUM – Premix						
Typ	Výkon (kW)		Cena v Kč			
	Jmenovitý	Minimální	VHMT1	VHMT2	VHMRT1	VHMRT2
PREMIX 18	18,0	8,1	53 700	52 000	-	52 500
PREMIX 25	25,0	8,8	55 200	55 300	55 000	55 000
PREMIX 32	32,0	9,6	61 400	58 000	58 000	58 500
PREMIX 40.1	39,8	10,0	61 500	58 500	61 800	61 000
PREMIX 50	50,0	12,5	69 100	66 000	66 100	67 100
PREMIX 60	60,0	15,0	69 700	-	67 000	68 000

MONZUN – Premix (TPM 068/08)

Příslušenství

PROSTOROVÝ PŘÍSTROJ QAA 70: prostorový přístroj Siemens QAA 70 s týdenním programem

PROSTOROVÝ PŘÍSTROJ QAA 88: prostorový přístroj Siemens QAA 88 bez týdenního programu

KOMUNIKAČNÍ ROZVADEČ KS/38-K32S: nadřazená regulace umožňující ovládání až 32ks jednotek Monzun Premix

Regulace – ovládání	
Typ	Cena v Kč
QAA 70	3 750
QAA 88	1 520
KS/38-K32S	20 600

Příslušenství	
Typ	Cena v Kč
Nosné konzole – sada	1 500
Závěs jednotky – „držák“ zavěšení	300
Konzole sestavy – sada	1 500
Závěs sestavy – „držák“ zavěšení	190
Otočný nástavec	1 900
Plynová hadice G 3/4“ délka 1000 mm	560

MONZUN Premix – směšovací komory				
Typ a velikost	Provedení a cena v Kč			
	s filtrem .01	s filtrem .57	bez filtru .01	bez filtru .57
VH RT 18	4 950	8 650	4 450	8 150
VH RT 25	4 950	8 650	4 450	8 150
VH RT 32	5 300	9 000	4 900	8 550
VH RT 40.1	5 300	9 000	4 900	8 550
VH RT 50	6 600	10 250	6 150	9 950
VH RT 60	6 600	10 250	6 150	9 950

Ovládání směšovací komory

.01 – ruční ovládání směšovací komory

.57 – ovládání směšovací komory servopohonem

MONZUN Premix – ostatní příslušenství		
	Typ a velikost	Cena v Kč
Díl průchodový	VH RT 18-25	1 400
	VH RT 32-40.1	1 600
	VH RT 50-60	2 350
Díl střešní	VH RT 18-25	1 850
	VH RT 32-40.1	2 050
	VH RT 50-60	2 500
Hlavice střešní	VH RT 18-25	4 250
	VH RT 32-40.1	4 450
	VH RT 50-60	5 500
Žaluzie protidešťová	VH RT 18-25	3 250
	VH RT 32-40.1	3 600
	VH RT 50-60	4 600
Vyúst'svislá úhlová	VH RT 18-25	1 150
	VH RT 32-40.1	1 500
	VH RT 50-60	2 000
Vyúst'stranová	VH RT 18-25	350
	VH RT 32-40.1	500
	VH RT 50-60	800
Vyúst'svislá křížová	VH RT 18-25	650
	VH RT 32-40.1	850
	VH RT 50-60	1 200

ROZVRSTVOVAČ DESTRIKÁTOR (TPM 048/05)

Podstropní ventilátor

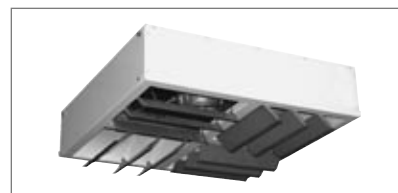

Aby nevznikal vysoký teplotní spád mezi horní a spodní částí prostoru a tím neefektivní vytápění, instalují se do místnosti rozvrstvovače, které zaručují nucené proudění ohřívaného vzduchu směrem dolů.

Rozvrstvovače						
	Provedení rozvrstvovače			Cena v Kč		
	D1	D2	D3	D1	D2	D3
Hmotnost (kg)	19,5	23	25,5	9 300	9 700	13 500
Napětí ventilátoru (V)	230	230	230			
Příkon ventilátoru (W)	280	370	630			
Průtok vzduchu při 20°C (m³h)	4 500	6 500	9 000			

Společnost Mandík, a. s. si vyhrazuje právo na aktualizaci ceníku.

MANDÍK a.s.

Dobříšská 550

267 24 Hostomice

Česká republika

Tel.: +420 311 706 706

Fax: +420 311 584 810

E-mail: mandik@mandik.cz

www.mandik.cz